

DVD Home Theatre System

Operating Instructions



DAV-FX80

WARNING

To prevent fire or shock hazard, do not expose the unit to rain or moisture.

Caution – The use of optical instruments with this product will increase eye hazard.

For the customers in the U.S.A

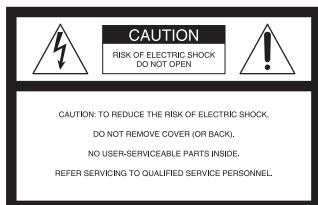

This symbol is intended to alert the user to the presence of uninsulated “dangerous voltage” within the product’s enclosure that may be of sufficient magnitude to constitute a risk of electric shock to persons.



This symbol is intended to alert the user to the presence of important operating and maintenance (servicing) instructions in the literature accompanying the appliance.

Owner’s Record

The model and serial numbers are located at the bottom of the unit. Record the serial number in the space provided below. Refer to them whenever you call upon your Sony dealer regarding this product.

Model No. DAV-FX80

Serial No. _____

WARNING

This equipment has been tested and found to comply with the limits for a Class B digital device, pursuant to Part 15 of the FCC Rules. These limits are designed to provide reasonable protection against harmful interference in a residential installation. This equipment generates, uses, and can radiate radio frequency energy and, if not installed and used in accordance with the instructions, may cause harmful interference to radio communications. However, there is no guarantee that interference will not occur in a particular installation. If this equipment does cause harmful interference to radio or television reception, which can be determined by turning the equipment off and on, the user is encouraged to try to correct the interference by one or more of the following measures:

- Reorient or relocate the receiving antenna (aerial).
- Increase the separation between the equipment and receiver.
- Connect the equipment into an outlet on a circuit different from that to which the receiver is connected.
- Consult the dealer or an experienced radio/TV technician for help.

CAUTION

You are cautioned that any changes or modifications not expressly approved in this manual could void your authority to operate this equipment.

Note to CATV system installer:

This reminder is provided to call the CATV system installer’s attention to Article 820-40 of the NEC that provides guidelines for proper grounding and, in particular, specifies that the cable ground shall be connected to the grounding system of the building, as close to the point of cable entry as practical.

For the customers in Canada

CAUTION

TO PREVENT ELECTRIC SHOCK, MATCH WIDE BLADE OF PLUG TO WIDE SLOT, FULLY INSERT.

Precautions

Safety

- If anything falls into the cabinet, unplug the unit and have it checked by qualified personnel before operating it any further.
- The unit is not disconnected from the AC power source (mains) as long as it is connected to the wall outlet (mains), even if the unit itself has been turned off.
- Unplug the unit from the wall outlet (mains) if you do not intend to use it for an extended period of time. To disconnect the cord, pull it out by the plug, never by the cord.

Installing

- Allow adequate air circulation to prevent internal heat buildup.
- Do not place the unit on surfaces (rugs, blankets, etc.) or near materials (curtains, draperies) that may block the ventilation slots.
- Do not install the unit near heat sources such as radiators, or air ducts, or in a place subject to direct sunlight, excessive dust, mechanical vibration, or shock.
- Do not install the unit in an inclined position. It is designed to be operated in a horizontal position only.

- Keep the unit and discs away from equipment with strong magnets, such as microwave ovens, or large loudspeakers.
- Do not place heavy objects on the unit.
- If the unit is brought directly from a cold to a warm location, moisture may condense inside the DVD Home Theatre System and cause damage to the lenses. When you first install the unit, or when you move it from a cold to a warm location, wait for about 30 minutes before operating the unit.



ENERGY STAR[®] is a U.S. registered mark.

As an ENERGY STAR[®] partner, Sony Corporation has determined that this product meets the ENERGY STAR[®] guidelines for energy efficiency.

Welcome!

Thank you for purchasing Sony DVD Home Theatre System. Before operating this system, please read this manual thoroughly and retain it for future reference.

Table of Contents

Welcome!	3	Searching by Scene.....	54
About This Manual	6	(Picture Navigation)	
This System Can Play the Following		Viewing Information About the Disc ...	55
Discs	6	Sound Adjustments	
Guide to the Control Menu Display	10	Changing the Sound	58
Getting Started		Enjoying Surround Sound by Using Sound	
Unpacking	13	Field.....	60
Inserting Batteries into the Remote.....	13	Enjoying TV or VCR Sound from All	
Hookup Overview	14	Speakers	62
Step 1: Speaker System Hookup.....	15	Using the Sound Effect.....	63
Step 2: Antenna (Aerial) Hookup	24	Using Various Additional	
Step 3: TV Hookup	25	Functions	
Step 4: Other Component Hookup.....	30	Changing the Angles	64
Step 5: Connecting the AC Power Cord		Displaying the Subtitles.....	64
(Mains Lead).....	32	Locking Discs	65
Step 6: Turning off		(CUSTOM PARENTAL	
the Demonstration.....	32	CONTROL, PARENTAL	
Step 7: Performing the Quick Setup	33	CONTROL)	
Speaker Setup.....	35	Other Operations	
Playing Discs		Controlling the TV with the Supplied	
Playing Discs	36	Remote	69
Using the DVD's Menu	41	Using the THEATRE SYNC	
Selecting [ORIGINAL] or [PLAY LIST]		Function.....	70
on a DVD-RW	42	Enjoying the Sound of Other	
Selecting a Playback Area for a Super		Components.....	72
Audio CD.....	42	Enjoying Multiplex Broadcast Sound ..	72
Playing VIDEO CDs with PBC Functions		(DUAL MONO)	
(Ver.2.0).....	43	Enjoying the Radio	73
(PBC Playback)		Using the Sleep Timer	75
About MP3 Audio Tracks and JPEG		Changing the Brightness of the Front	
Image Files	44	Panel Display.....	76
Playing DATA CDs with MP3 Audio		Returning to the Default Settings	76
Track and JPEG Image Files	46		
Playing Audio Tracks and Images as a			
Slide Show with Sound.....	48		
Adjusting the Delay Between the Picture			
and Sound	50		
(A/V SYNC)			
Searching for a Particular Point on			
a Disc	51		
(Scan, Slow-motion Play, Freeze			
Frame)			
Searching for a Title/Chapter/Track/			
Scene, etc.	52		

Settings and Adjustments

Using the Setup Display.....	77
Setting the Display or Sound Track	
Language	78
[LANGUAGE SETUP]	
Settings for the Display.....	79
[SCREEN SETUP]	
Custom Settings	81
[CUSTOM SETUP]	
Settings for the Speakers.....	82
[SPEAKER SETUP]	

Additional Information

Precautions.....	85
Notes about the Discs.....	86
Troubleshooting	86
Self-diagnosis Function	89
(When letters/numbers appear in the display)	
Specifications	90
Glossary	91
Language Code List	94
Index to Parts and Controls.....	95
DVD Setup Display List	100
AMP Menu List	102
Index	103

About This Manual

- The instructions in this manual describe the controls on the remote. You can also use the controls on the system if they have the same or similar names as those on the remote.
- The Control Menu items may be different depending on the area.
- “DVD” may be used as a general term for DVD VIDEOS, DVD+RWs/DVD+Rs, and DVD-RWs/DVD-Rs.
- Measurements are expressed in feet (ft) for North American models.
- The following symbols are used in this manual.

Symbol	Meaning
	Functions available for DVD VIDEOS, DVD-Rs/DVD-RWs in video mode, and DVD+Rs/DVD+RWs
	Functions available for DVD-RWs in VR (Video Recording) mode
	Functions available for VIDEO CDs (including Super VCDs or CD-Rs/CD-RWs in video CD format or Super VCD format)
	Functions available for Super Audio CDs
	Functions available for music CDs or CD-Rs/CD-RWs in music CD format
	Functions available for DATA CDs (CD-ROMs/CD-Rs/CD-RWs containing MP3* audio tracks and JPEG image files)

* MP3 (MPEG1 Audio Layer 3) is a standard format defined by ISO/MPEG which compresses audio data.

This System Can Play the Following Discs

Format of discs	Disc logo
DVD VIDEO	
DVD-RW	
VIDEO CD	
Super Audio CD	
Audio CD	
CD-R/CD-RW (audio data) (MP3 files) (JPEG files)	   

The “DVD VIDEO” logo and “DVD-RW” logo are trademarks.

Note about CDs

The system can play CD-ROMs/CD-Rs/CD-RWs recorded in the following formats:

- audio CD format
- video CD format
- MP3 audio tracks and JPEG image files of format conforming to ISO 9660 Level 1/Level 2, or its extended format, Joliet

Example of discs that the system cannot play

The system cannot play the following discs:

- CD-ROMs/CD-Rs/CD-RWs other than those recorded in the formats listed on page 6
- CD-ROMs recorded in PHOTO CD format
- Data part of CD-Extras
- DVD Audios
- DVD-RAMs

Also, the system cannot play the following discs:

- A DVD VIDEO with a different region code (page 8, 93).
- A disc that has a non-standard shape (e.g., card, heart).
- A disc with paper or stickers on it.
- A disc that has the adhesive of cellophane tape or a sticker still left on it.

Notes about CD-R/CD-RW/DVD-R/DVD-RW/DVD+R/DVD+RW

In some cases, CD-R/CD-RW/DVD-R/DVD-RW/DVD+R/DVD+RW cannot be played on this system due to the recording quality or physical condition of the disc, or the characteristics of the recording device and authoring software.

The disc will not play if it has not been correctly finalized. For more information, see the operating instructions for the recording device.

Note that discs created in the Packet Write format cannot be played.

Music discs encoded with copyright protection technologies

This product is designed to play back discs that conform to the Compact Disc (CD) standard.

Recently, various music discs encoded with copyright protection technologies are marketed by some record companies. Please be aware that among those discs, there are some that do not conform to the CD standard and may not be playable by this product.

Note on DualDisc

A DualDisc is a two sided disc product which mates DVD recorded material on one side with digital audio material on the other side.

However, since the audio material side does not conform to the Compact Disc (CD) standard, playback on this product is not guaranteed.

Note on PBC (Playback Control) (VIDEO CDs)

This system conforms to Ver. 1.1 and Ver. 2.0 of VIDEO CD standards. You can enjoy two kinds of playback depending on the disc type.

Disc type	You can
VIDEO CDs without PBC functions (Ver. 1.1 discs)	Enjoy video playback (moving pictures) as well as music.
VIDEO CDs with PBC functions (Ver. 2.0 discs)	Play interactive software using menu screens displayed on the TV screen (PBC Playback), in addition to the video playback functions of Ver. 1.1 discs. Moreover, you can play high-resolution still pictures, if they are included on the disc.

About Multi Session CD

- This system can play Multi Session CDs when an MP3 audio track is contained in the first session. Any subsequent MP3 audio tracks recorded in later sessions can also be played back.
- This system can play Multi Session CDs when a JPEG image file is contained in the first session. Any subsequent JPEG image files recorded in later sessions can also be played back.
- If audio tracks and images in music CD format or video CD format are recorded in the first session, only the first session will be played back.

About the Super Audio CD

Super Audio CD is a new high-quality audio disc standard where music is recorded in the DSD (Direct Stream Digital) format (conventional CDs are recorded in the PCM format). The DSD format, using a sampling

continued

frequency 64 times higher than that of a conventional CD, and with 1-bit quantization, achieves both a wide frequency range and a wide dynamic range across the audible frequency range, and so provides music reproduction extremely faithful to the original sound.

Types of Super Audio CDs

There are two types of discs, depending on the Super Audio CD layer and CD layer combination.

- Super Audio CD layer: A high-density signal layer for Super Audio CD
- CD layer*¹: A layer that is readable by a conventional CD player

Single layer disc
(a disc with a single Super Audio CD layer)

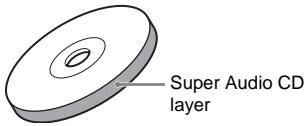

Hybrid disc*²
(a disc with a Super Audio CD layer and a CD layer)

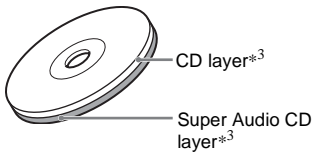

A Super Audio CD layer consists of the 2 channel area or the multi-channel area.

- 2 channel area: An area in which 2 channel stereo tracks are recorded
- Multi-channel area: An area in which multi-channel (up to 5.1 channels) tracks are recorded

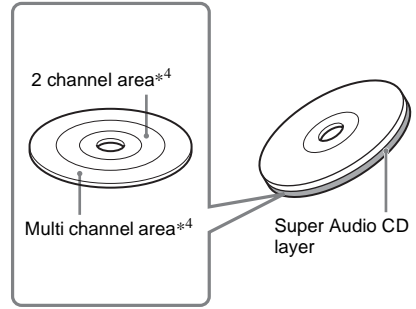

- *1 You can play the CD layer on a conventional CD player.
- *2 Since both layers are on one side, it is not necessary to turn the disc over.
- *3 To select a layer, see "Selecting a Playback Area for a Super Audio CD" (page 42).
- *4 To select an area, see "Selecting a Playback Area for a Super Audio CD" (page 42).

Region code

Your system has a region code printed on the back of the unit and will only play DVDs labeled with the same region code.

DVD VIDEOS labeled  will also play on this system.

If you try to play any other DVD VIDEO, the message [Playback prohibited by area limitations.] will appear on the TV screen. Depending on the DVD VIDEO, no region code indication may be given even though playing the DVD VIDEO is prohibited by area restrictions.

Note on playback operations of DVDs and VIDEO CDs

Some playback operations of DVDs and VIDEO CDs may be intentionally set by software producers. Since this system plays DVDs and VIDEO CDs according to the disc contents the software producers designed, some playback features may not be available. Also, refer to the instructions supplied with the DVDs or VIDEO CDs.

Copyrights

This product incorporates copyright protection technology that is protected by U.S. patents and other intellectual property rights. Use of this copyright protection technology must be authorized by Macrovision, and is intended for home and other limited viewing uses only unless otherwise authorized by Macrovision. Reverse engineering or disassembly is prohibited.

This system incorporates with Dolby*¹ Digital and Dolby Pro Logic (II) adaptive matrix surround decoder and the DTS*² Digital Surround System.

*1 Manufactured under license from Dolby Laboratories.

“Dolby,” “Pro Logic,” and the double-D symbol are trademarks of Dolby Laboratories.

*2 Manufactured under license from Digital Theater Systems, Inc.

“DTS” and “DTS Digital Surround” are trademarks of Digital Theater Systems, Inc.

Guide to the Control Menu Display

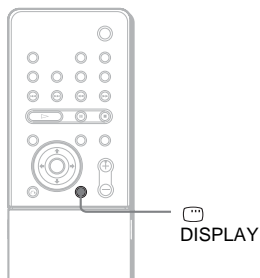

Use the Control Menu to select a function and to view related information. Press DISPLAY repeatedly to turn on or change the Control Menu display as follows:

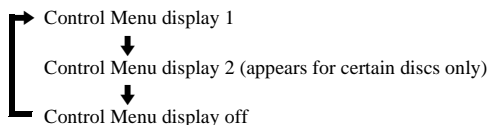

Control Menu display

The Control Menu display 1 and 2 will show different items depending on the disc type. For details about each item, see the pages in parentheses.

Example: Control Menu display 1 when playing a DVD VIDEO.

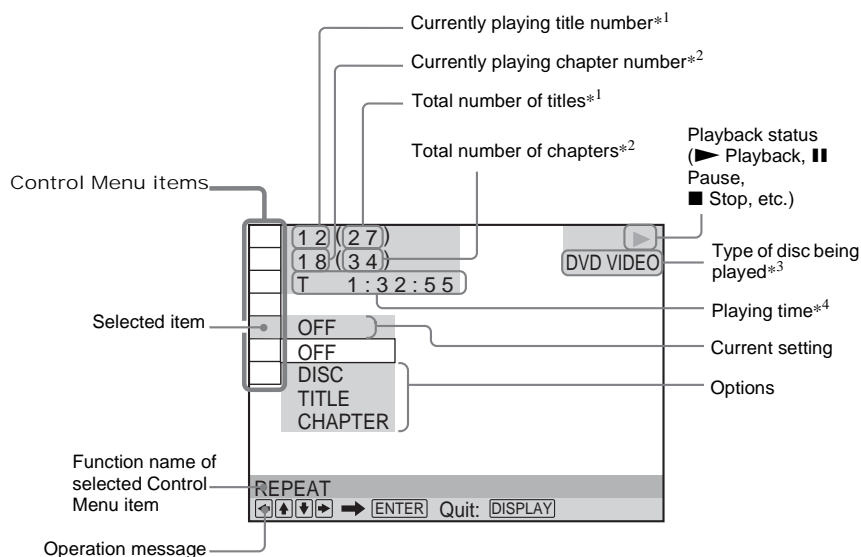





















































- *1 Displays the scene number for VIDEO CDs (PBC is on), track number for VIDEO CDs/Super Audio CDs/CDs, album number for DATA CDs.
- *2 Displays the index number for VIDEO CDs/Super Audio CDs, MP3 audio track number, or JPEG image file number for DATA CDs.
- *3 Displays Super VCD as "SVCD." Displays "MP3" in the Control Menu display 1 or "JPEG" in the Control Menu 2 for DATA CDs.
- *4 Displays the date for JPEG files.













To turn off the display

Press  DISPLAY.



List of Control Menu items

Item	Item Name, Function, Relevant Disc Type
	[TITLE] (page 52)/[SCENE] (page 52)/[TRACK] (page 52) Selects the title, scene, or track to be played.   
	[CHAPTER] (page 52)/[INDEX] (page 52) Selects the chapter or index to be played.   
	[INDEX] (page 52) Displays the index and selects the index to be played. 
	[TRACK] (page 52) Selects the track to be played.   
	[ORIGINAL/PLAY LIST] (page 42) Selects the type of titles (DVD-RW) to be played, the [ORIGINAL] one, or an edited [PLAY LIST]. 
	[TIME/TEXT] (page 53) Checks the elapsed time and the remaining playback time. Input the time code for picture and music searching. Displays the DVD/CD text or the MP3 track name.      
	[MULTI/2CH] (page 42) Selects the playback area on Super Audio CDs when available. 
	[PROGRAM] (page 38) Selects the track to play in the order you want.   
	[SHUFFLE] (page 39) Plays the track in random order.   
	[REPEAT] (page 40) Plays the entire disc (all titles/all tracks/all albums) repeatedly or one title/chapter/track/album repeatedly.      
	[PARENTAL CONTROL] (page 65) Sets to prohibit playback on this system.    
	[SETUP] (page 77) [QUICK] Setup (page 33) Use Quick Setup to choose the desired language of the on-screen display, the aspect ratio of the TV, and the size of the speakers you are using. [CUSTOM] Setup In addition to the Quick Setup setting, you can adjust various other settings. [RESET] Returns the settings in [SETUP] to the default setting.      

continued

	[ALBUM] (page 52) Selects the album to be played.	
	[FILE] (page 52) Selects the JPEG image file to be played.	
	[DATE] (page 57) Displays the date the picture was taken by a digital camera.	
	[INTERVAL] (page 49) Specifies the duration for which the slides are displayed on the screen.	
	[EFFECT] (page 50) Selects the effects to be used for changing slides during a slide show.	
	[MODE (MP3, JPEG)] (page 48) Selects the data type; MP3 audio track (AUDIO), JPEG image file (IMAGE) or both (AUTO) to be played when playing a DATA CD	

Tip

- The Control Menu icon indicator lights up in green  →  when you select any item except [OFF] ([PROGRAM], [SHUFFLE], [REPEAT] only). The [ORIGINAL/PLAY LIST] indicator lights up in green when you select [PLAY LIST] (default setting). The [MULTI/2CH] indicator lights up in green when you select the multi-channel playback area on a Super Audio CD.

Check that you have the following items:

- Speakers (5)
- Subwoofer (1)
- Posts (long × 2, short × 2)
- Bases (2)
- Terminal covers (2)
- Screws (10)
- AM loop antenna (aerial) (1)
- FM wire antenna (aerial) (1)
- Speaker cords (5 m × 4, 15 m × 2)
(16.5 ft. × 4, 49.5 ft. × 2)
- Video Cord (1)
- Remote Commander (remote) (1)
- Size AAA (R03) batteries (2)
- Wall-mount pads
- Operating Instructions
- Speaker and TV connections (card) (1)

Inserting Batteries into the Remote

You can control the system using the supplied remote. Insert two size AAA (R03) batteries by matching the ⊕ and ⊖ ends on the batteries to the markings inside the compartment. When using the remote, point it at the remote sensor  on the system.

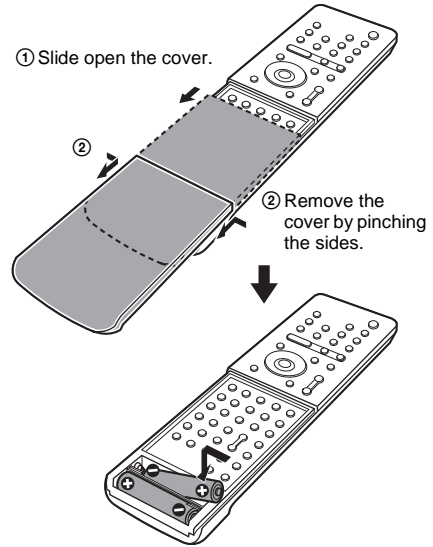

Note

- Do not leave the remote in an extremely hot or humid place.
- Do not use a new battery with an old one.
- Do not drop any foreign object into the remote casing, particularly when replacing the batteries.
- Do not expose the remote sensor to direct light from the sun or lighting apparatus. Doing so may cause a malfunction.
- If you do not intend to use the remote for an extended period of time, remove the batteries to avoid possible damage from battery leakage and corrosion.

Hookup Overview

Perform all connections and settings by following Steps 1 to 7.

“Step 1: Speaker System Hookup” (page 15)

“Step 2: Antenna (Aerial) Hookup” (page 24)

“Step 3: TV Hookup” (page 25)

“Step 4: Other Component Hookup” (page 30)

“Step 5: Connecting the AC Power Cord (Mains Lead)” (page 32)

“Step 6: Turning off the Demonstration” (page 32)

“Step 7: Performing the Quick Setup” (page 33)

Video signal is sent to the TV, and is output from the TV screen; audio signals are processed by this system and output from the speakers of this system. You can also enjoy sound of other sources, such as TV programs, in addition to DVDs or CDs.

Step 1: Speaker System Hookup

Connect the supplied speaker system using the supplied speaker cords by matching the colors of the jacks to those of the cords. Do not connect any speakers other than those supplied with this system. To obtain the best possible surround sound, specify the speaker parameters (distance, level, etc.) on page 82.

Required cords

Speaker cords

The connector and the color tube of the speaker cords are the same color as the label of the jacks to be connected.

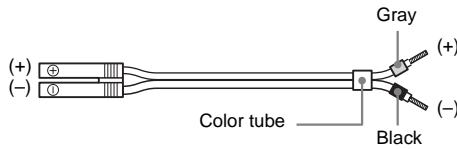

Attaching the speaker stand to the speaker

(Front speakers only)

Before connecting the speakers, attach the speaker stand to the speaker.

Note

- Spread a cloth on the floor to avoid damaging the floor.

Tip

- You can use the speaker without the speaker stand by installing it on the wall (page 21).

1 Insert the post into the base.

The long post is for floor use, the short post is for tabletop use.

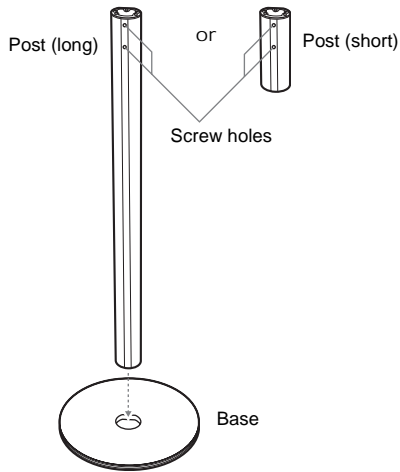

2 Secure the base to the post by screws.

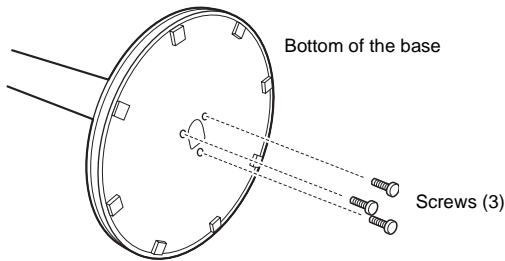

3 Draw the speaker cord through the hole on the base, then stand it up.

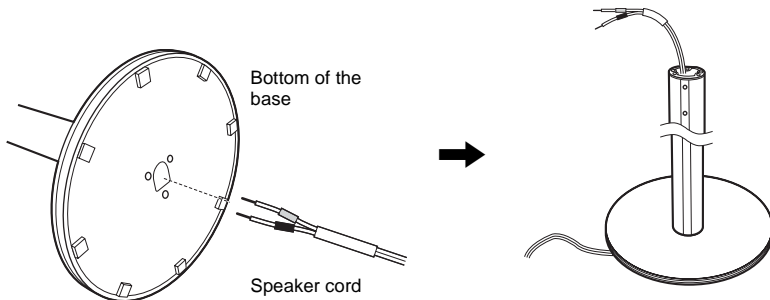

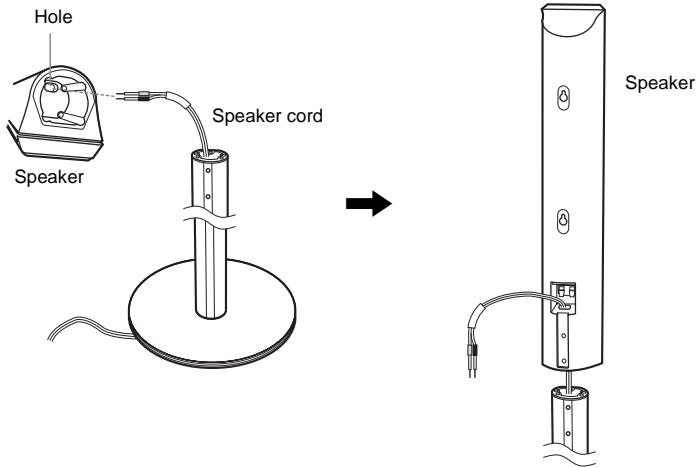
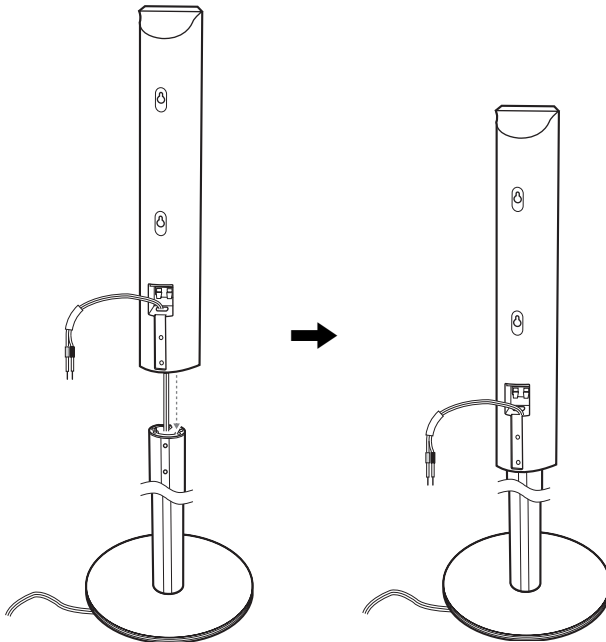
4 Draw the speaker cord through the hole on the speaker.**5** Mount the speaker on the post.**Note**

- Do not catch the speaker cord between the speaker and the post.
- Do not drop the speaker when mounting.

6 Connect the speaker cord to the speaker, then adjust the length of the speaker cord.

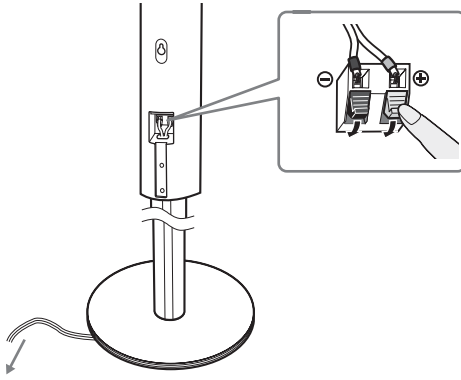

Adjust the length of the speaker cord.

7 Attach the terminal cover to the speaker by screws.

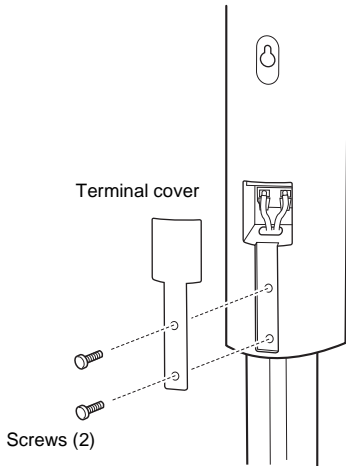

Connecting the speakers

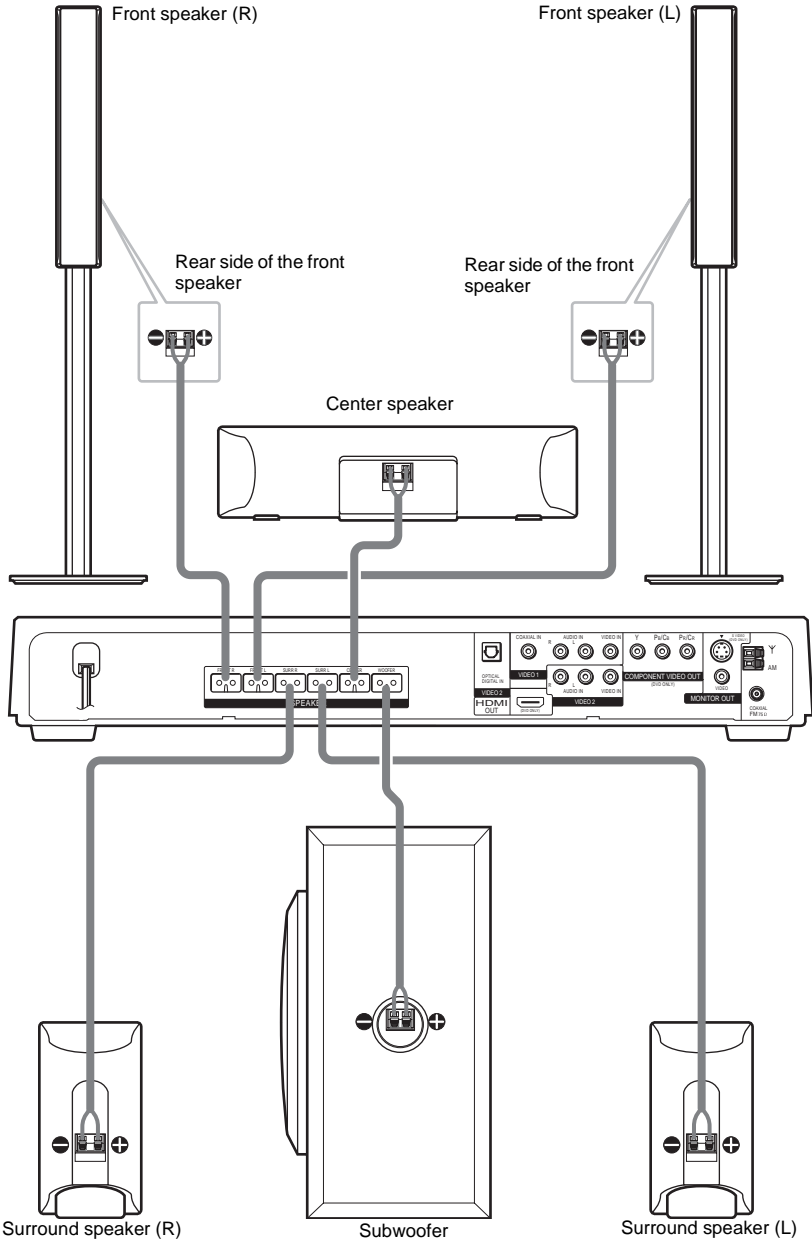

Note

- Do not set the speakers in an inclined position.

continued

- Do not place the speakers in locations that are:
 - Extremely hot or cold
 - Dusty or dirty
 - Very humid
 - Subject to vibrations
 - Subject to direct sunlight
- Use caution when placing the speakers and/or speaker stands (not supplied) that are attached with the speakers on a specially treated (waxed, oiled, polished, etc.) floor, as staining or discoloration may result.
- When cleaning, use a soft cloth such as a cleaning cloth for glasses.
- Do not use any type of abrasive pad, scouring powder, or solvent such as alcohol or benzine.
- Do not lean or hang on the speaker, as the speaker may fall down.

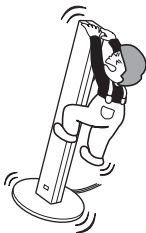

To connect the speaker cords

Connect the speaker cords after bending the bare wire at the end of the insulation. This prevents the speaker insulation from being inserted in the speaker terminal.

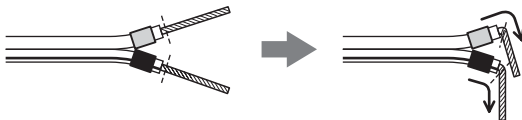

Note

- Do not catch the speaker cord insulation in the SPEAKER jack.

Avoiding short-circuiting the speakers

Short-circuiting of the speakers may damage the system. To prevent this, be sure to follow these precautions when connecting the speakers. Make sure the bare wire of each speaker cord does not touch another speaker terminal or the bare wire of another speaker cord.

Examples of poor conditions of the speaker cord

Stripped speaker cord is touching another speaker terminal.

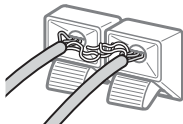

Stripped cords are touching each other due to excessive removal of insulation.

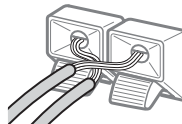

After connecting all the components, speakers, and AC power cord (mains lead), output a test tone to check that all the speakers are connected correctly. For details on outputting a test tone, see page 83. If no sound is heard from a speaker while outputting a test tone, or a test tone is output from a speaker other than the one currently displayed on the Setup Display, the speaker may be short-circuited. If this happens, check the speaker connection again.

Note

- Be sure to match the speaker cord to the appropriate terminal on the components: \oplus to \oplus , and \ominus to \ominus . If the cords are reversed, the sound will lack bass and may be distorted.

Installing the speakers on the wall

- 1 Prepare screws (not supplied) that are suitable for the hole on the back of each speaker. See the illustrations below.**

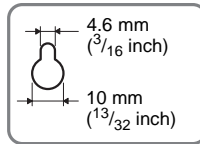
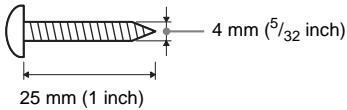

Hole on the back of the speaker

- 2 Fasten the screws to the wall.**

The screws should protrude 7 to 8 mm ($\frac{9}{32}$ to $\frac{11}{32}$ inch) for the front speakers, 8 to 9 mm ($\frac{11}{32}$ to $\frac{3}{8}$ inch) for the surround speakers.

For the front speakers

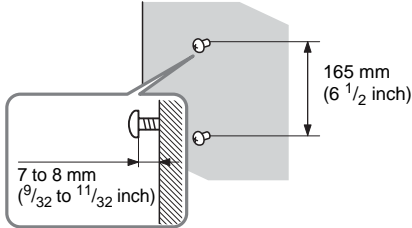

For the surround speakers

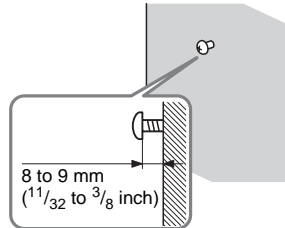

- 3 Peel the seals off the two screw points on the rear of the speaker. (Front speakers only)**

continued

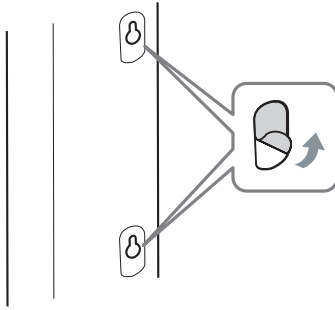

4 Attach the wall-mount pads on the rear side of the speaker.

Front speaker

Surround speaker

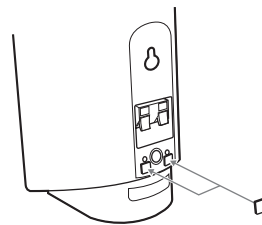
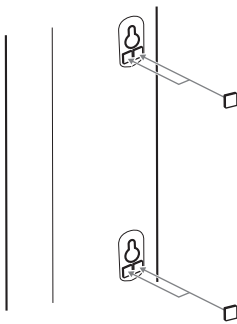

Wall-mount pads
(7 × 7 mm, 3 mm thick)
($\frac{9}{32} \times \frac{9}{32}$ inch, $\frac{1}{8}$ inch thick)

Wall-mount pads
(7 × 7 mm, 3 mm thick)
($\frac{9}{32} \times \frac{9}{32}$ inch, $\frac{1}{8}$ inch thick)

5 Hang the speakers on the screws.

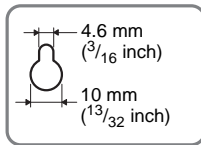

Hole on the back of the speaker

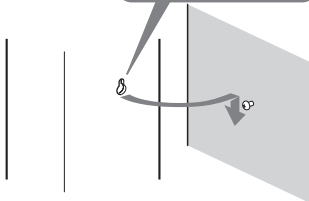

Note

- Use screws that are suitable for the wall material and strength. As a plaster board wall is especially fragile, attach the screws securely to a beam and fasten them to the wall. Install the speakers on a vertical and flat wall where reinforcement is applied.
- Contact a screw shop or installer regarding the wall material or screws to be used.
- Sony is not responsible for accident or damage caused by improper installation, insufficient wall strength or improper screw installation, natural calamity, etc.

Step 2: Antenna (Aerial) Hookup

Connect the supplied AM/FM antennas (aerials) for listening to the radio.

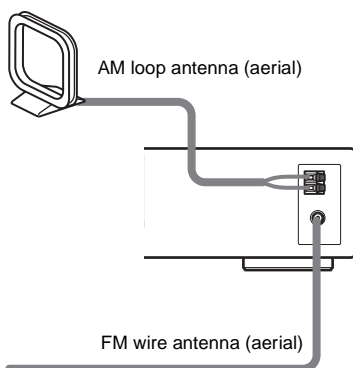

Note

- To prevent noise pickup, keep the AM loop antenna (aerial) away from the system and other components.
- Be sure to fully extend the FM wire antenna (aerial).
- After connecting the FM wire antenna (aerial), keep it as horizontal as possible.

Tip

- When you connect the supplied AM loop antenna (aerial), cord (A) or cord (B) can be connected to either terminal.

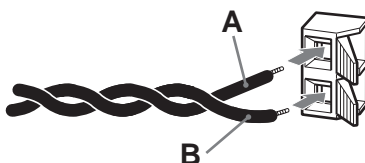

- If you have poor FM reception, use a 75-ohms coaxial cable (not supplied) to connect the system to an outdoor FM antenna (aerial) as shown below.

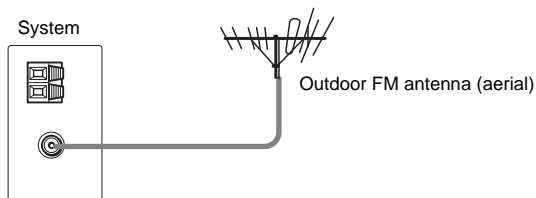

Step 3: TV Hookup

First, perform the video connection, and then audio connection.

With your TV's audio output connected to this system, you can listen to TV sound through the system speakers.

Connecting the video/HDMI* cords

Sends a played back DVD image to a TV.

Check the jacks of your TV, and choose the **A**, **B**, **C**, or **D** connection. Picture quality improves in order from **A** (standard) to **D** (component).

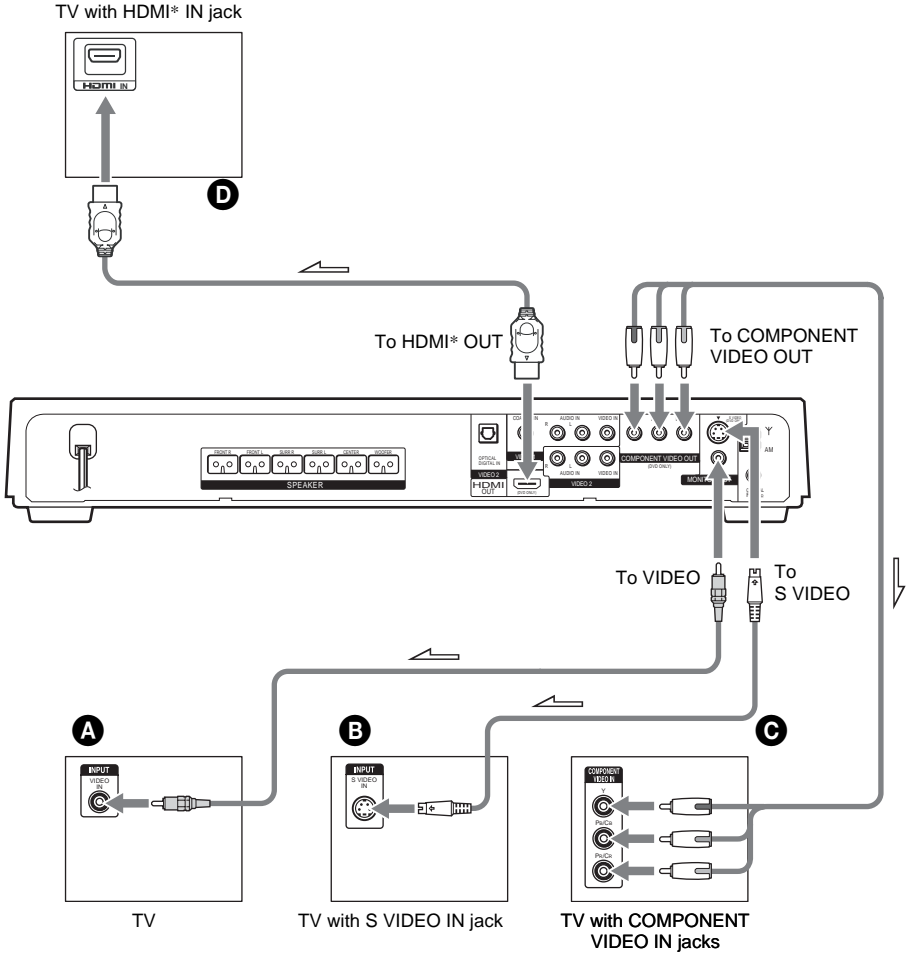

* HDMI (high-definition multimedia interface)

The system is based on version 1.1 of High-Definition Multimedia Interface Specifications.

continued

The system incorporates High-Definition Multimedia Interface (HDMI™) technology.

HDMI, the HDMI logo and High-Definition Multimedia Interface trademarks or registered trademarks of HDMI Licensing LLC.

A To connect to a TV with the VIDEO IN jacks

Connect the video cord.



B To connect to a TV with the S VIDEO IN jack

Connect an S video cord (not supplied). When using the S video jack instead of the video jacks, your TV monitor must also be connected via an S video jack. S video signals are on a separate bus from the video signals and will not be output through the video jacks.



C To connect to a TV with the COMPONENT VIDEO IN jacks

Connect a component video cord (not supplied). To use the COMPONENT VIDEO OUT jacks (Y, PB/CB, PR/CR) instead of the video jacks, your TV monitor must be equipped with via COMPONENT VIDEO IN jacks (Y, PB/CB, PR/CR). If your TV accepts progressive format signals, you must use this connection and set the output channel of the system to progressive format (page 27).

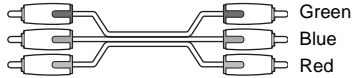

D To connect to a TV with the HDMI (high-definition multimedia interface)/DVI (digital visual interface) input jack

Use a certified HDMI (high-definition multimedia interface) cord (not supplied) to enjoy high quality digital picture and sound through the HDMI OUT (high-definition multimedia interface out) jack. Note that Super Audio CD sound is not output from the HDMI OUT (high-definition multimedia interface out) jack.

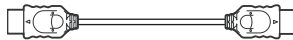

To connect to a TV with DVI (digital visual interface) input

Use an HDMI (high-definition multimedia interface)-DVI (digital visual interface) converter cord (not supplied) with an HDMI (high-definition multimedia interface)-DVI (digital visual interface) adaptor (not supplied). The DVI (digital visual interface) jack will not accept any audio signals. Furthermore, you cannot connect the HDMI OUT (high-definition multimedia interface out) jack to DVI (digital visual interface) jacks that are not HDCP (high-bandwidth digital content protection) compliant (e.g., DVI (digital visual interface) jacks on PC displays).

When connecting to a standard 4:3 screen TV

Depending on the disc, the image may not fit your TV screen.

To change the aspect ratio, see page 79.

Does your TV accept progressive signals?

Progressive is the method for displaying TV images which reduces flickering, and sharpens the image. To display using this method, you need to connect to a TV that accepts progressive signals.

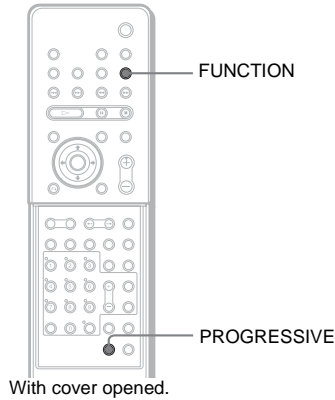

“P AUTO” or “P VIDEO” appears in the front panel display when the system outputs progressive signals.

- 1 Press FUNCTION repeatedly to select “DVD.”**
- 2 Press PROGRESSIVE.**

Each time you press PROGRESSIVE, the display changes as follows:

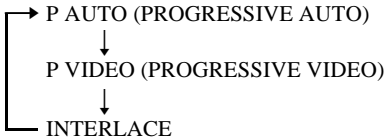

■ P AUTO (PROGRESSIVE AUTO)

Select this setting when:

- your TV accepts progressive signals, and,
- the TV is connected to the COMPONENT VIDEO OUT jacks.

Normally select this under the above condition. This automatically detects the software type, and selects the appropriate conversion method.

Note that the picture will not be clear or no picture will appear if you select these settings when either of the above conditions is not met.

■ P VIDEO (PROGRESSIVE VIDEO)

Select this setting when:

- your TV accepts progressive signals, and,
 - the TV is connected to the COMPONENT VIDEO OUT jacks, and,
 - you want to fix the conversion method to PROGRESSIVE VIDEO for video-based software.
- Select this if the image is not clear when you select PROGRESSIVE AUTO.

Note that the picture will not be clear or no picture will appear if you select these settings when

continued

either of the above conditions is not met.

■ INTERLACE

Select this setting when:

- your TV does not accept progressive signals, or,
- your TV is connected to jacks other than the COMPONENT VIDEO OUT jacks (MONITOR OUT (VIDEO/S VIDEO)).

About DVD software types and the conversion method

DVD software can be divided into 2 types: film-based software and video-based software.

Video-based software is derived from TV, such as dramas and sit-coms, and displays images at 30 frames/60 fields per second. Film-based software is derived from film and displays images at 24 frames per second. Some DVD software contains both video and film.

In order for these images to appear natural on your screen when output in progressive format, the progressive signals need to be converted to match the type of DVD software that you are watching.

Note

- When you play video-based software in progressive signal format, sections of some types of images may appear unnatural due to the conversion process when output through the COMPONENT VIDEO OUT jacks. Even though you set to “PROGRESSIVE AUTO” or “PROGRESSIVE VIDEO,” images from the MONITOR OUT (VIDEO or S VIDEO) jack are unaffected as they are output in the interlace format.

Connecting the audio cords

Outputs TV sound through the speakers of this system.

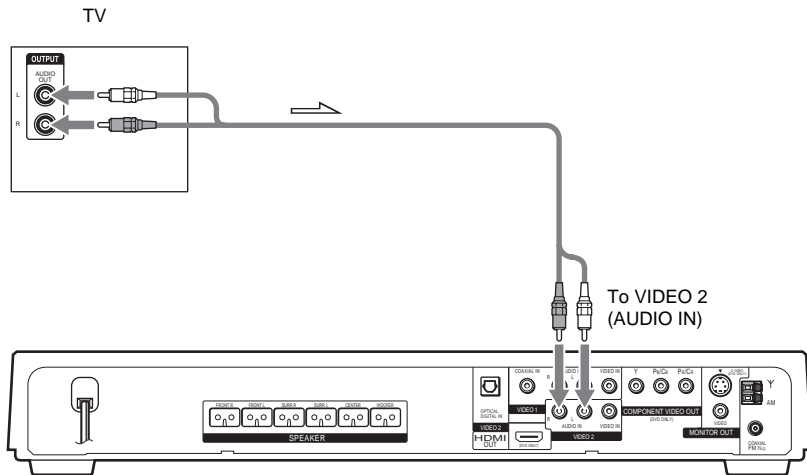

To connect the AUDIO OUT jacks of a TV to the VIDEO 2 (AUDIO IN) jacks of this system

Connect a TV to the VIDEO 2 (AUDIO IN) jacks using an audio cord (not supplied). When connecting a cord, be sure to match the color-coded sleeves to the appropriate jacks on the components.

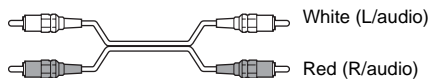

Note

- Be sure to make connections securely to avoid hum and noise.
- If your TV does not have AUDIO OUT jacks, you cannot output the TV sound from the speakers of this system.

Tip

- To listen to the TV sound, select the function by pressing FUNCTION. For details, see page 62.
- When you want to output the TV sound or stereo sound of a 2 channel source from the 6 speakers, select the "Dolby Pro Logic," "Dolby Pro Logic II MOVIE," or "Dolby Pro Logic II MUSIC" sound field (page 60).

Step 4: Other Component Hookup

You can enjoy other component by connecting the VIDEO/AUDIO OUT jacks of another component.

Connecting the system and the other component

Outputs the other component through the speakers of this system.

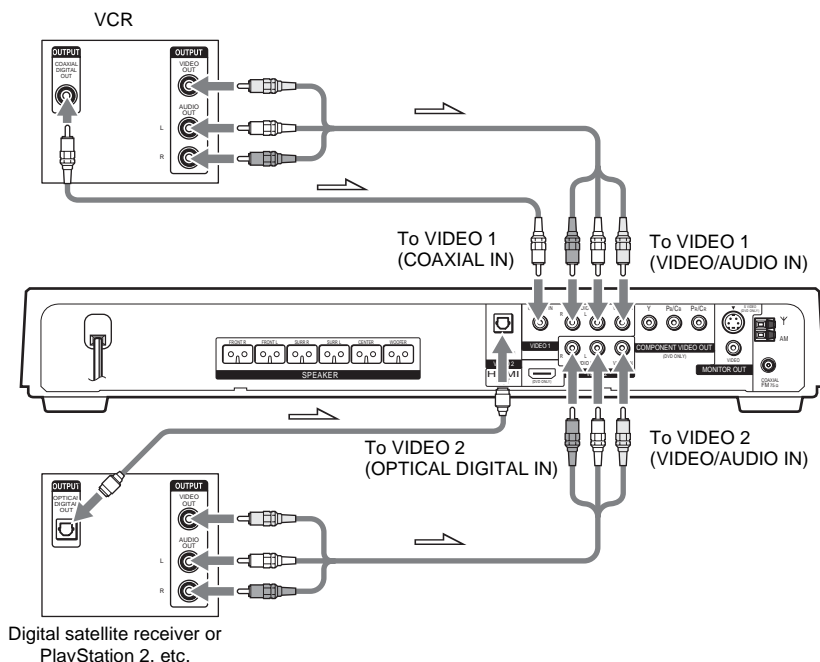

To connect the VIDEO/AUDIO OUT jacks of other component to the VIDEO 1 or VIDEO 2 (VIDEO/AUDIO IN) jacks of this system

Connect the VCR or other components to the VIDEO 1 or VIDEO 2 (VIDEO/AUDIO IN) jacks using the video/audio cord (not supplied). When connecting a cord, be sure to match the color-coded sleeves to the appropriate jacks on the components.

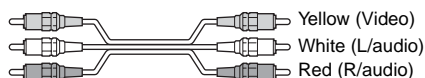

If you connect a digital satellite receiver with an DIGITAL OUT (COAXIAL or OPTICAL) jack

The digital satellite receiver can be connected to the VIDEO 1 COAXIAL IN or VIDEO 2 OPTICAL DIGITAL IN jack instead of the VIDEO 1 or VIDEO 2 AUDIO IN jacks of the system.

The system can accept both the digital and analogue signals. Digital signals have priority over analogue signals. If the digital signal ceases, the analogue signal will be processed after 2 seconds.

If you connect a digital satellite receiver without an DIGITAL OUT jack
Connect the digital satellite receiver to the VIDEO 1 or VIDEO 2 AUDIO IN jacks only of the system.

Note

- Be sure to make connections securely to avoid hum and noise.

Tip

- When you connect another component to the system, you can enjoy the component by pressing FUNCTION (page 72).

Step 5: Connecting the AC Power Cord (Mains Lead)

Before connecting the AC power cord (mains lead) of this system to a wall outlet (mains), connect the speakers to the system (page 15).

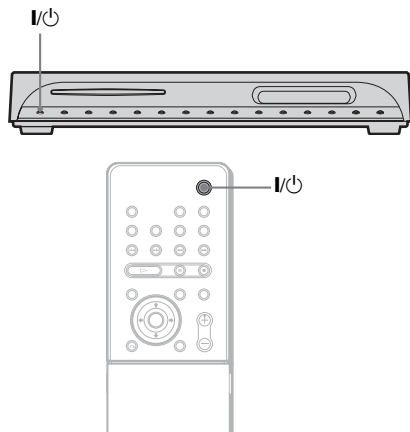

To turn on the system

Press **I/⏻**.

To turn off the system

Press **I/⏻**. The system enters standby mode. While playing a disc, do not turn off the system by pressing **I/⏻**. Doing so may cancel the menu settings. When you turn off the system, first press **■** to stop playback and then press **I/⏻**.

Step 6: Turning off the Demonstration

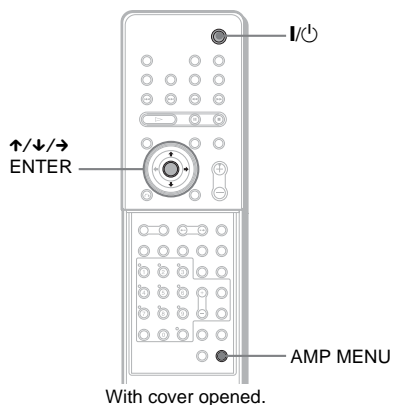

With cover opened.

After connecting the AC power cord (mains lead), the demonstration appears in the front panel display. When you press **I/⏻** on the remote, the demonstration turns off.

Note

- When you press **I/⏻** on the system, the demonstration does not turn off.
- When you set the demonstration mode in the AMP menu to on, the demonstration does not turn off even though you press **I/⏻** on the remote. To turn off the demonstration, set the demonstration mode to off, then press **I/⏻** on the remote.

Setting the demonstration mode on/off

- 1 Press AMP MENU.**
- 2 Press \uparrow/\downarrow repeatedly until “DEMO” appears in the front panel display, then press ENTER or \rightarrow .**
- 3 Press \uparrow/\downarrow to select the setting.**
 - DEMO OFF: sets the demonstration mode off.
 - DEMO ON: sets the demonstration mode on.
- 4 Press ENTER or AMP MENU.**
The AMP menu turns off.

Step 7: Performing the Quick Setup

Follow the steps below to make the minimum number of basic adjustments for using the system.

To skip an adjustment, press ►►. To return to the previous adjustment, press ◀◀.

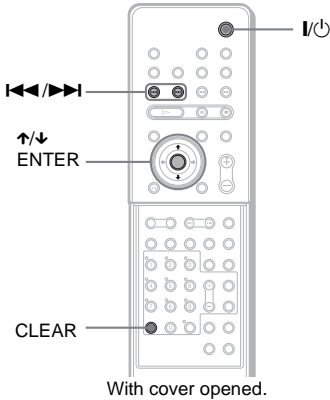

1 Turn on the TV.

2 Press I/⏻.

Note

- Disconnect the headphone when you perform the Quick Setup. You cannot operate steps after 8 with the headphone connected.
- Make sure that the function is set to “DVD.”

3 Switch the input selector on your TV so that the signal from the system appears on the TV screen.

[Press [ENTER] to run QUICK SETUP.] appears at the bottom of the screen. If this message does not appear, display the Quick Setup and perform again (page 34).

Note

- When you press CLEAR in message, the message disappears. When you need to perform the Quick Setup, see “To recall the Quick Setup display” (page 34).

4 Press ENTER without inserting a disc.

The Setup Display for selecting the language used in the on-screen display appears.

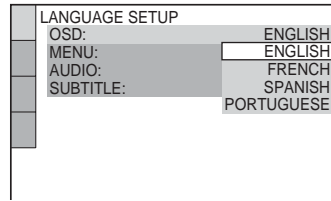

5 Press ↕/ to select a language.

The system displays the menu and subtitles in the selected language.

Note

- The selectable language is different depending on the area.

6 Press ENTER.

The Setup Display for selecting the aspect ratio of the TV to be connected appears.

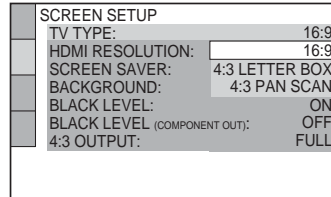

7 Press ↕/ to select the setting that matches your TV type.

■ If you have a 4:3 standard TV [4:3 LETTER BOX] or [4:3 PAN SCAN] (page 79)

■ If you have a wide-screen TV or a 4:3 standard TV with a wide-screen mode [16:9] (page 79)

8 Press ENTER.

The Setup Display for selecting the speaker distance appears.

9 Press ↕/ to select the front speaker distance from the listening position, then press ENTER.

You can set from 1.0 to 7.0 meters (4 to 23 ft).

continued

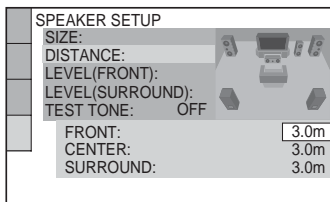

10 Press **↑/↓** to select the center speaker distance from the listening position, then press **ENTER**.

You can set from 0.0 to 7.0 meters (0 to 23 ft).

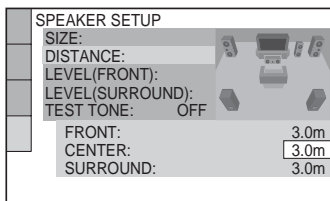

Note

- The setting range changes depending on the front speaker setting.

11 Press **↑/↓** to select the surround speaker distance from the listening position.

You can set from 0.0 to 7.0 meters (0 to 23 ft).

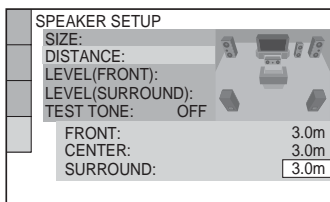

Note

- The setting range changes depending on the front speaker setting.

12 Press **ENTER**.

Quick Setup is finished. All connections and setup operations are complete.

To quit the Quick Setup

Press **⏏** **DISPLAY** in any Step.

Note

- If you want to change each setting, see “Using the Setup Display” (page 77).

To recall the Quick Setup display

1 Press **⏏** **DISPLAY** when the system is in stop mode.

The Control Menu appears.

2 Press **↑/↓** to select **[SETUP]**, then press **ENTER**.

The options for [SETUP] appear.

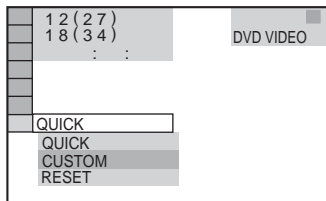

3 Press **↑/↓** to select [QUICK], then press **ENTER**.

The Quick Setup display appears.

Speaker Setup

Positioning the speakers

For the best possible surround sound, all the speakers other than the subwoofer should be the same distance from the listening position (A). However, this system allows you to place the center speaker up to 1.6 meters (5 ft) closer (B) and the surround speakers up to 5.0 meters (16 ft) closer (C) to the listening position. The front speakers can be placed from 1.0 to 7.0 meters (4 to 23 ft) (A) from the listening position.

Place speakers as illustrated below.

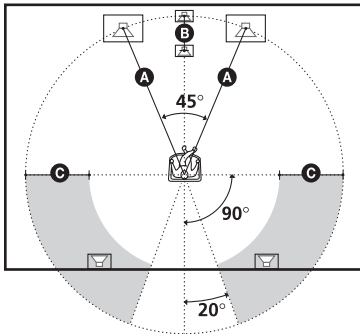

Note

- Do not place the center and surround speakers farther away from the listening position than the front speakers.

If you encounter color irregularity on a nearby TV screen

The front and center speakers and the subwoofer are magnetically shielded to allow it to be installed near a TV set. However, color irregularities may still be observed on certain types of TV sets. As the surround speakers are not magnetically shielded, we recommend that you place the surround speakers slightly further away from TV set.

If color irregularity is observed...

Turn off the TV set once, then turn it on again after 15 to 30 minutes.

If color irregularity is observed again...

Place the speaker further away from the TV set.

If howling occurs

Reposition the speakers or turn down the volume on the system.

Playing Discs

Playing Discs

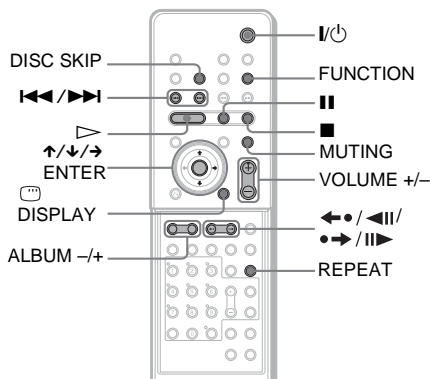
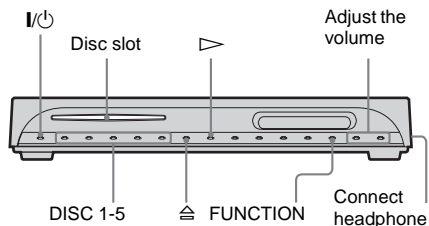

With cover opened.

Depending on the DVD VIDEO or VIDEO CD, some operations may be different or restricted. Refer to the operation details supplied with your disc.

- 1 Turn on your TV.**
- 2 Switch the input selector on the TV to this system.**
- 3 Press I/O.**
The system turns on.
Unless the system is set to "DVD," press FUNCTION to select "DVD."
- 4 Press DISC 1-5.**
Press the button of the disc number you want.

When no disc is in the disc stocker you selected, "No Disc" appears. Perform next Step while "*DISC-1*" (eg., 2-5) flashes.

5 Press .

6 Load a disc.

Push the disc into the disc slot until the disc is pulled in automatically.

The disc is drawn into the system automatically.

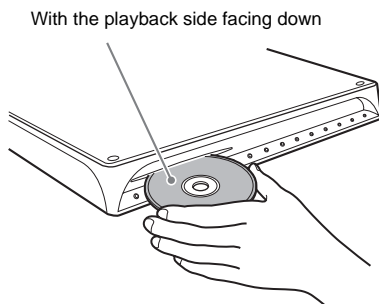

To load other discs, press DISC 1-5 (that is not loaded with a disc) and and load the disc.

The system starts playback (continuous play) of the disc whose DISC indicator is green.

To play back other discs, press DISC SKIP on the remote or DISC 1-5 of the system. Adjust the volume on the system.

TIP

- The DISC 1-5 indicators change color as follows:
 - green: the disc is selected, or the disc is being played back.
 - off: there is no disc.
 - orange: a disc is loaded in the disc stocker but not selected.
 - The indicator turns off if an unplayable disc is inserted.
- Depending on the disc, a menu may appear on the TV screen. You can play the disc interactively by following the instructions on the menu. (DVD: page 41), (VIDEO CD: page 43).

To save the power in standby mode

Press I/O while the system turns on. To cancel standby mode, press I/O once.

Additional operations

To	Press
Stop	■
Pause	⏸
Resume play after pause	⏸ or ▶
Go to the next chapter, track, or scene	▶▶ (except for JPEG)
Go back to the preceding chapter, track, or scene	◀◀ (except for JPEG)
Mute the sound	MUTING. To cancel muting, press it again or VOLUME + to adjust the sound volume.
Change a disc while playing another disc	DISC SKIP
Play the desired disc directly	DISC 1-5 on the system.
Stop play and remove the desired disc	DISC 1-5 and ⏻ on the system.
Replay the previous scene* ¹	◀•/⏸ (instant replay) during playback.
Briefly fast forward the current scene* ²	•▶/⏸▶ (instant advance) during playback.
Go to the next or previous album* ³	ALBUM + or – during playback.

*1 DVD VIDEOS/DVD-RWs/DVD-Rs only.

*2 DVD VIDEOS/DVD-RWs/DVD-Rs/DVD+RWs only.

*3 DATA CDs only.

Note

- If there is no disc in the system, “No Disc” appears in the front panel display.

Tip

- The Instant Replay function is useful when you want to review a scene or dialogue that you missed.
- The Instant Advance function is useful when you want to pass over a scene that you don’t want to watch.
- You may not be able to use the Instant Replay or Instant Advance function with some scenes.

About DVD 5-DISC changer

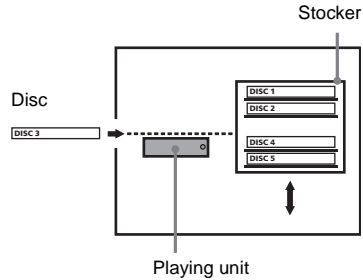

The disc changer consists of a playing unit and a stocker which transports the discs to the disc slot and the playing unit.

For example, if you press DISC 3, the stocker moves until the DISC 3 comes to the position of the playing unit and then moves the DISC 3 over the playing unit.

Note

- Do not insert discs while playing.
- Noise may come from the disc changer when changing discs or turning the system on and off. However, this is just noise produced by the operation of the internal mechanisms and does not indicate a malfunction.
- 8 cm (3-inch) CDs or DVDs cannot be stored in the stocker.

Do not insert an 8 cm (3-inch) CD with an 8 cm (3-inch) adapter. It may damage the system and disc.

Resuming playback from the point where you stopped the disc (Resume Play)

When you stop the disc, the system remembers the point where you pressed ■ and “Resume” appears in the front panel display. As long as you do not remove the disc, Resume Play will work even if the system enters standby mode by pressing I/⏻.

1 While playing a disc, press ■ to stop playback.

“Resume” appears in the front panel display, so you can restart the disc from the point where you stopped the disc.

If “Resume” does not appear, Resume Play is not available.

2 Press \triangleright .

The system starts playback from the point where you stopped the disc in Step 1.

Note

- If [MULTI-DISC RESUME] in [CUSTOM SETUP] is set to [OFF] (page 81), the resume point is cleared when you change the function by pressing FUNCTION.
- The point where you stopped playing may be cleared when:
 - you change the play mode.
 - you change the settings on the Setup Display.
 - you change the function by pressing FUNCTION.
 - you disconnect the AC power cord (mains lead).
- For DVD-RWs in VR mode, CDs, Super Audio CDs, and DATA CDs, the system remembers the resume playback point for the current disc. The resume point is cleared when:
 - you eject the disc.
 - the system enters standby mode (DATA CD only).
- Resume Play does not work during Program Play and Shuffle Play.
- This function may not work with some discs.
- Depending on where you stop the disc, the system may not resume playback from exactly the same point.

Tip

- To play from the beginning of the disc, press \blacksquare twice, then press \triangleright .

To enjoy a disc that is played before by resume playback (Multi-disc Resume)

(DVD VIDEO, VIDEO CD only)

This system stores the point where you stopped the disc for up to 40 discs and resumes playback the next time you insert the same disc. If you store a resume playback point for the 41st disc, the resume playback point for the first disc is deleted.

To activate this function, set [MULTI-DISC RESUME] in [CUSTOM SETUP] to [ON]. For details, see “[MULTI-DISC RESUME] (DVD VIDEO/VIDEO CD only)” (page 81).

Note

- If [MULTI-DISC RESUME] in [CUSTOM SETUP] is set to [ON] (page 81) and you playback a recorded

disc such as DVD-RW, the system may playback other recorded discs from the same resume point. To play from the beginning, press \blacksquare twice and then press \triangleright .

Creating your own program (Program Play)

(VIDEO CD, Super Audio CD, CD only)

You can play the contents of a disc in the order you want by arranging the order of the tracks on the disc to create your own program. You can program up to 99 tracks.

Note

- You can program the track on the current disc only.

1 Press \square DISPLAY.

The Control Menu appears.

2 Press \uparrow/\downarrow to select [PROGRAM], then press ENTER.

The options for [PROGRAM] appear.

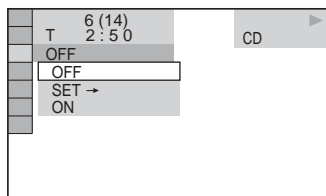

3 Press \uparrow/\downarrow to select [SET →], then press ENTER.

[TRACK] is displayed when you play a VIDEO CD, Super Audio CD, or CD.

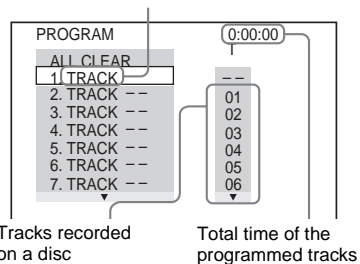

4 Press \rightarrow .

The cursor moves to the track row [T] (in this case, [01]).

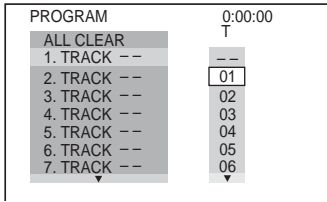

5 Select the track you want to program.

For example, select track [02]. Press **↑/↓** to select [02] under [T], then press **ENTER**. The track number may be displayed in 3 digits for a Super Audio CD.

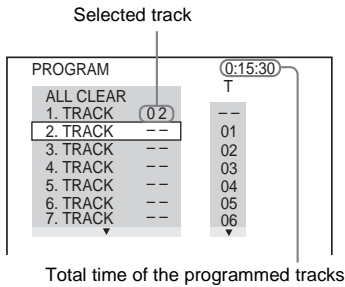

6 To program other tracks, repeat steps 4 to 5.

The programmed tracks are displayed in the selected order.

7 Press **▷ to start Program Play.**

Program Play starts. When the program ends, you can restart the same program again by pressing **▷**.

To return to normal play

Press **CLEAR**, or select [OFF] in Step 2. To play the same program again, select [ON] in Step 3 and press **ENTER**.

To turn off the Control Menu

Press **DISPLAY** repeatedly until the Control Menu is turned off.

To change or cancel a program

- 1 Follow steps 1 to 3 of "Creating your own program (Program Play)."
- 2 Select the program number of the track you want to change or cancel using **↑/↓**. If you

want to delete the track from the program, press **CLEAR**.

- 3 Follow Step 5 for new programming. To cancel a program, select [--] under [T], then press **ENTER**.

To cancel all of the tracks in the programmed order

- 1 Follow steps 1 to 3 of "Creating your own program (Program Play)."
- 2 Press **↑** and select [ALL CLEAR].
- 3 Press **ENTER**.

Tip

- You can perform Shuffle Play or Repeat Play of programmed tracks. During Program Play, follow the steps of Shuffle Play (page 39) or Repeat Play (page 40).

Note

- All Discs Repeat is automatically changed into Program Repeat when you set to program play mode. You can only program the contents of the current disc.
- When you change the disc by pressing **DISC SKIP** or **DISC 1-5**, programmed tracks are canceled.
- You cannot use this function with **VIDEO CDs** and **Super VCDs** with **PBC** playback.

Playing in random order (Shuffle Play)

(VIDEO CD, Super Audio CD, CD only)

You can have the system "shuffle" tracks. Subsequent "shuffling" may produce a different playing order.

Note

- You can shuffle the track on the current disc only.

1 Press **DISPLAY during playback.**

The Control Menu appears.

2 Press **↑/↓ to select **[SHUFFLE]**, then press **ENTER**.**

The options for [SHUFFLE] appear.

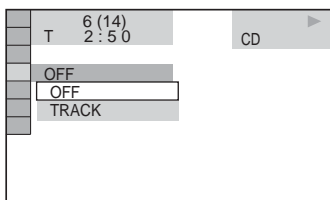

3 Press \uparrow/\downarrow to select the item to be shuffled.

■ **When playing a VIDEO CD, Super Audio CD, or CD**

- [TRACK]: shuffles tracks on the disc.

■ **When Program Play is activated**

- [ON]: shuffles tracks selected in Program Play.

4 Press ENTER.

Shuffle Play starts.

To return to normal play

Press CLEAR, or select [OFF] in Step 2.

To turn off the Control Menu

Press \square DISPLAY repeatedly until the Control Menu is turned off.

Tip

- You can set Shuffle Play while the system is stopped. After selecting the [SHUFFLE] option, press \triangleright . Shuffle Play starts.

Note

- You cannot use this function with VIDEO CDs and Super VCDs with PBC playback.

Playing repeatedly (Repeat Play)

You can play all of the titles, tracks or albums on a disc or a single title, chapter, track, or album repeatedly.

You can use a combination of Shuffle or Program Play modes.

1 Press \square DISPLAY during playback.

The Control Menu appears.

2 Press \uparrow/\downarrow to select \square [REPEAT], then press ENTER.

The options for [REPEAT] appear.

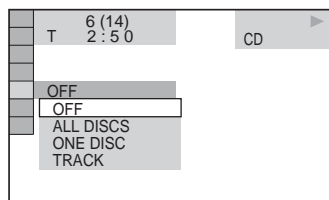

3 Press \uparrow/\downarrow to select the item to be repeated.

The default setting is underlined.

■ **When playing a DVD VIDEO or DVD-RW**

- [OFF]: does not play repeatedly.
- [ALL DISCS]: repeats all of the discs.
- [ONE DISC]: repeats all of the titles on the current disc. (When playing a DVD-RW in VR mode, [ONE DISC] repeats all of the titles of the selected type.)
- [TITLE]: repeats the current title on a disc.
- [CHAPTER]: repeats the current chapter.

■ **When playing a VIDEO CD, Super Audio CD, or CD**

- [OFF]: does not play repeatedly.
- [ALL DISCS]: repeats all of the discs.
- [ONE DISC]: repeats all of the tracks on the current disc.
- [TRACK]: repeats the current track.

■ **When playing a DATA CD**

- [OFF]: does not play repeatedly.
- [ALL DISCS]: repeats all of the discs.
- [ONE DISC]: repeats all of the albums on the current disc.
- [ALBUM]: repeats the current album.
- [TRACK] (MP3 audio tracks only): repeats the current track.

4 Press ENTER.

The item is selected.

To return to normal play, press CLEAR, or select [OFF] in Step 2.

To turn off the Control Menu

Press \square DISPLAY repeatedly until the Control Menu is turned off.

Tip

- You can set Repeat Play while the system is stopped. After selecting the [REPEAT] option, press \triangleright . Repeat Play starts.
- You can quickly display the [REPEAT] status by pressing REPEAT. Each time you press REPEAT, the [REPEAT] option changes.

Note

- You cannot use this function with VIDEO CDs and Super VCDs with PBC playback.
- When playing a DATA CD which contains MP3 audio track and JPEG image files, and their playing time are not the same, the audio sound will not match the image.
- When [MODE (MP3, JPEG)] is set to [IMAGE (JPEG)] (page 48), you cannot select [TRACK].

Using the DVD's Menu

DVD-V

A DVD is divided into a lot of sections, which make up a picture or music feature. These sections are called "titles." When you play a DVD which contains several titles, you can select the title you want using TOP MENU. When you play DVDs that allow you to select items such as the language for the subtitles and the language for the sound, select these items using MENU.

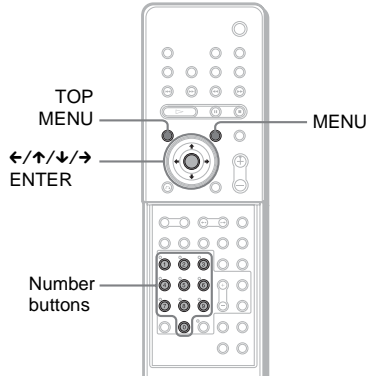

With cover opened.

- 1 Press TOP MENU or MENU.**
The disc's menu appears on the TV screen. The contents of the menu vary from disc to disc.
- 2 Press $\leftarrow/\uparrow/\downarrow/\rightarrow$ or the number buttons to select the item you want to play or change.**
- 3 Press ENTER.**

Selecting [ORIGINAL] or [PLAY LIST] on a DVD-RW

DVD-RW

Some DVD-RWs in VR (Video Recording) mode have two types of titles for playback: originally recorded titles ([ORIGINAL]) and titles that can be created on recordable DVD players for editing ([PLAY LIST]). You can select the type of title to be played.

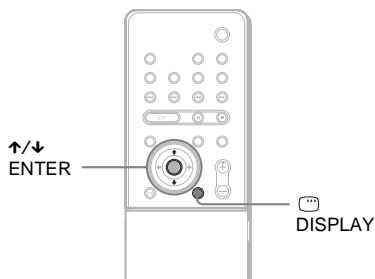

- 1 Press **DISPLAY** when the system is in stop mode.

The Control Menu appears.

- 2 Press **↑/↓** to select **[ORIGINAL/PLAY LIST]**, then press **ENTER**.

The options for [ORIGINAL/PLAY LIST] appear.

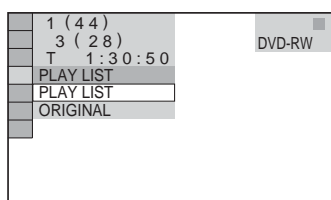

- 3 Press **↑/↓** to select a setting.

- [PLAY LIST]: plays the titles created from [ORIGINAL] for editing.
- [ORIGINAL]: plays the titles originally recorded.

- 4 Press **ENTER**.

Selecting a Playback Area for a Super Audio CD

SA-CD

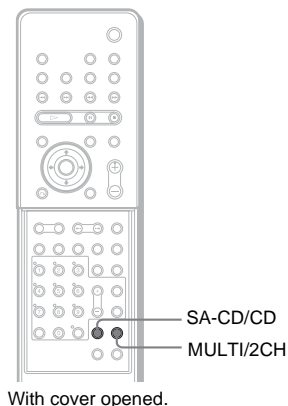

Selecting a playback area on a 2 channel + Multi-channel Super Audio CD

Some Super Audio CDs consist of a 2 channel playback area and a multi-channel playback area. You can select the playback area you want to listen to.

- 1 Press **MULTI/2CH** when the system is in stop mode.

The following display appears.

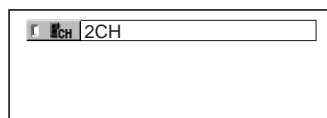

- 2 Press **MULTI/2CH** repeatedly to select the item.

- [MULTI]: plays a multi-channel playback area.
- [2CH]: plays a 2 channel playback area. "MULTI" lights up in the front panel display when playing a multi-channel playback area.

Note

- You cannot change a playback area during playback.

Selecting a playback layer when playing a hybrid Super Audio CD

Some Super Audio CDs consist of an HD layer and a CD layer. You can select the playback layer you want to listen to.

Press SA-CD/CD when the system is in stop mode.

Each time you press the button, an HD layer or a CD layer is alternately selected. When playing a CD layer, “CD” lights up in the front panel display.

Note

- For details about Super Audio CD discs, see page 7.
- Each play mode function works only within the selected layer or playback area.
- You cannot change a playback layer during playback.
- When you select a CD layer, you cannot change a playback area by pressing MULTI/2CH.
- Super Audio CD audio signals are not output from the HDMI OUT (high-definition multimedia interface out) jack.

Playing VIDEO CDs with PBC Functions (Ver.2.0)

(PBC Playback)



With PBC (Playback Control) functions, you can enjoy simple interactive operations, search functions, and other such operations. PBC playback allows you to play VIDEO CDs interactively by following the menu on the TV screen.

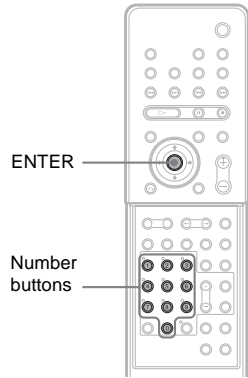

With cover opened.

- 1 Start playing a VIDEO CD with PBC functions.**
The menu for your selection appears.
- 2 Select the item number you want by the number buttons.**
- 3 Press ENTER.**
- 4 Follow the instructions in the menu for interactive operations.**

Refer to the operation details supplied with the disc, as the operating procedure may differ depending on the VIDEO CD.

To go back to the menu

Press RETURN.

Note

- Depending on the VIDEO CD, the menu does not appear in Step 1.

continued

- Depending on the VIDEO CD, [Press ENTER] in Step 3 may appear as [Press SELECT] in the instructions supplied with the disc. In this case, press \triangleright .

Tip

- To play without using PBC, press \lll/\ggg or the number buttons while the system is stopped to select a track, then press \triangleright or ENTER. [Play without PBC] appears on the TV screen and the system starts continuous play. You cannot play still pictures such as a menu. To return to PBC playback, press \blacksquare twice, then press \triangleright .

About MP3 Audio Tracks and JPEG Image Files



What is MP3/JPEG?

MP3 is audio compression technology that satisfies the ISO/MPEG regulations. JPEG is image compression technology.

Discs that the system can play

You can play back DATA CDs (CD-ROMs/CD-Rs/CD-RWs) recorded in MP3 (MPEG1 Audio Layer 3) and JPEG format. However, the discs must be recorded according to ISO 9660 Level 1, Level 2 or Joliet format for the system to recognize the tracks (or files). You can also play discs recorded in Multi Session.

See the instructions supplied with the CD-R/CD-RW drives and the recording software (not supplied) for details on the recording format.

About the multi-session disc

If MP3 audio tracks or JPEG image files are recorded in the first session, the system will also play MP3 audio tracks or JPEG image files in other sessions. If audio tracks and images in audio CD format or video CD format are recorded in the first session, only the first session will be played back.

Note

- The system may not be able to play some DATA CDs created in the Packet Write format. In this case, you cannot view the JPEG images recorded.

MP3 audio track or JPEG image file that the system can play

The system can play the MP3 audio tracks or JPEG image files:

- which have the extension “.MP3” (MP3 audio track) or “.JPG”/“.JPEG” (JPEG image file)
- which conform to the DCF* image file format

* “Design rule for Camera File system”: Image standards for digital cameras regulated by Japan Electronics and Information Technology Industries Association (JEITA).

Note

- The system will play any data with the extension “.MP3,” “.JPG,” or “.JPEG” even if they are not in MP3 or JPEG format. Playing this data may generate a loud noise which could damage your speaker system.
- The system does not conform to audio in MP3PRO format.

Playback order of MP3 audio tracks or JPEG image files

The playback order of MP3 audio tracks or JPEG image files recorded on a DATA CD is as follows:

■ Structure of disc contents

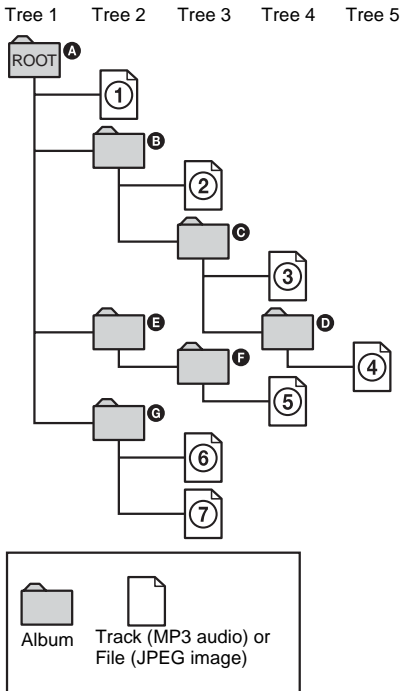

When you insert a DATA CD, the numbered tracks (or files) are played sequentially, from ① through ⑦. Any sub-albums/tracks (or files) contained within a currently selected album take

priority over the next album in the same tree. (Example: ③ contains ④ so ④ is played before ⑤.)

When you press MENU and the list of album names appears (page 46), the album names are arranged in the following order:

① → ② → ③ → ④ → ⑥ → ⑤. Albums that do not contain tracks (or files) (such as album ⑤) do not appear in the list.

Tip

- If you add numbers (01, 02, 03, etc.) to the front of the track/file names when you store the tracks (or files) in a disc, the tracks and files will be played in that order.
- Since a disc with many trees takes longer to start playback, it is recommended that you create albums with no more than two trees.

Note

- Depending on the software you use to create the DATA CD, the playback order may differ from the illustration.
- The playback order above may not be applicable if there are more than 200 albums and 300 files in each album.
- The system can recognize up to 200 albums (the system will count just albums, including albums that do not contain MP3 audio tracks and JPEG image files). The system will not play any albums beyond the 200th album.
- The system may take longer time to playback, when progressing to the following album or jump to other album.
- Some type of JPEG files cannot be played.

Playing DATA CDs with MP3 Audio Track and JPEG Image Files



MP3 audio tracks and JPEG image files recorded on DATA CDs (CD-ROMs/CD-Rs/CD-RWs) can be played on this system.

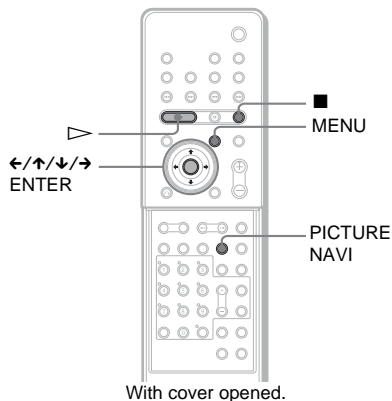

With cover opened.

Tip

- You can view the disc information while playing MP3 audio tracks and JPEG image files (page 55).
- You can select Repeat Play while playing MP3 audio tracks and JPEG image files (page 40) and [AUDIO] while playing an MP3 audio track (page 58).

Selecting an album

1 Load a DATA CD.

The system starts playing from the first album.

2 Press MENU.

The list of albums recorded on the DATA CD appears. When an album is being played, its title is shaded.

You can turn the album list on and off by pressing MENU.



3 Press \uparrow/\downarrow to select the album you want and press \triangleright .

The system starts playing the selected album.

To stop playback

Press \blacksquare .

To play the next or previous MP3 audio track

Press \lll/\ggg . Note that you can select the next album by continuing to press \ggg after the last track on the first album, but that you cannot return to the previous album by pressing \lll .

To return to the previous album, select the album from the album list.

To play the next or previous JPEG image file

Press \leftarrow/\rightarrow when the Control Menu is not displayed. Note that you can select the next album by continuing to press \rightarrow after the last image on the first album, but that you cannot return to the previous album by pressing \leftarrow . To return to the previous album, select the album from the album list.

To turn off the display

Press MENU.

Selecting an MP3 audio track

1 Load a DATA CD.

The system starts playing from the first album.

2 Press MENU.

The albums recorded on the DATA CD appear. When an album is being played, its title is shaded.

3 Press \uparrow/\downarrow to select an album and press ENTER.

The list of tracks contained in the album appears.

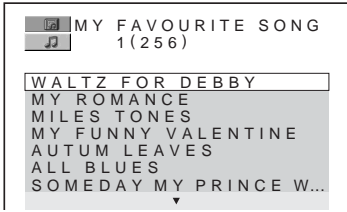

4 Press \uparrow/\downarrow to select a track and press ENTER.

The selected track starts playing. You can turn the track list off by pressing MENU. Pressing MENU again will display the album list.

To stop playback

Press ■.

To play the next or previous MP3 audio track

Press $\blacktriangleleft/\blacktriangleright$. Note that you can select the next album by continuing to press \blacktriangleright after the last track on the first album, but that you cannot return to the previous album by pressing \blacktriangleleft .

To return to the previous album, select the album from the album list.

To return to the previous display

Press \curvearrowright RETURN.

To turn off the display

Press MENU.

Selecting a JPEG image file

1 Load a DATA CD.

The system starts playing from the first album.

2 Press MENU.

The albums recorded on the DATA CD appear. When an album is being played, its title is shaded.

3 Press \uparrow/\downarrow to select an album and press PICTURE NAVI.

Images of files in the album appear in 16 subscreens.

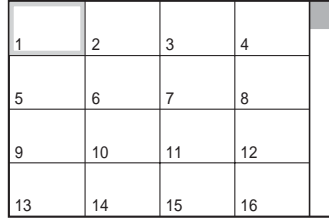

4 Press $\leftarrow/\uparrow/\downarrow/\rightarrow$ to select the image you want to view and press ENTER.

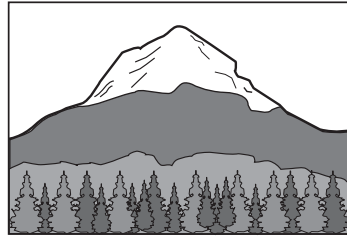

To play the next or previous JPEG image file

Press \leftarrow/\rightarrow when the Control Menu is not displayed. Note that you can select the next album by continuing to press \rightarrow after the last image on the first album, but that you cannot return to the previous album by pressing \leftarrow . To return to the previous album, select the album from the album list.

To rotate a JPEG image

When a JPEG image file is displayed on the screen, you can rotate the image by 90 degrees. Press \uparrow/\downarrow while viewing an image. Each time you press \uparrow , the image rotates counterclockwise by 90 degrees.

Example of when you press \uparrow once:

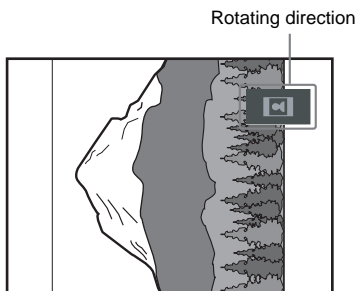

Press CLEAR to return to normal view.

Note

- Nothing happens when you press ← while playing the first image file of the album.
- If you press ←/→ to go to the next or previous image, the “Rotating a JPEG image” function is canceled.
- The slide show stops when you press ↑/↓.

To stop playback

Press ■.

Tip

- A scroll box is displayed at the right side of the screen. To display the additional image files, select the bottom image and press ↓. To return to the previous image, select the top image and press ↑.
- You can also change the slide show duration (page 49) and effect (page 50) while playing JPEG image file.

Playing Audio Tracks and Images as a Slide Show with Sound

DATA CD

You can play a slide show with sound by first placing both MP3 and JPEG files in the same album on a DATA CD. When you play back the DATA CD, select [AUTO] mode as explained below.

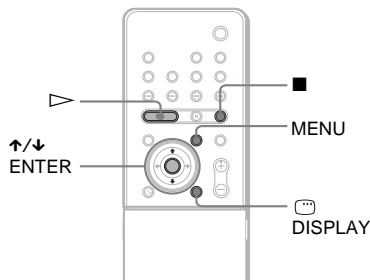

1 Load a DATA CD.

The system starts playing from the first album.

2 Press ■.

The system stops playback.

3 Press DISPLAY.

The Control Menu appears.

4 Press ↑/↓ to select [MODE (MP3, JPEG)], then press ENTER.

The options for [MODE (MP3, JPEG)] appear.

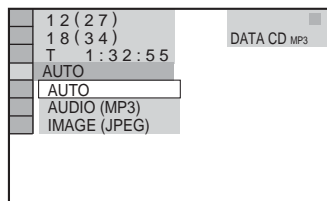

5 Press ↑/↓ to select the setting you want and press ENTER.

The default setting is underlined.

- [AUTO]: plays both the JPEG image files and MP3 audio tracks in the same album as a slide show.
- [AUDIO (MP3)]: plays only MP3 audio tracks continuously.
- [IMAGE (JPEG)]: plays only JPEG image files as a slide show.

6 Press MENU.

The list of albums recorded on the DATA CD appears.

7 Press \uparrow/\downarrow to select the album you want and press \triangleright .

The system starts playing the selected album.

You can turn the album list on and off by pressing MENU repeatedly.

Tip

- You can also change the slide show duration (page 49) and effect (page 50) while playing JPEG image files.
- If you want to play a slide show to the same audio track, set the track to Repeat Play (page 40).
- When you select [AUTO], the system can recognize up to 300 MP3 tracks and 300 JPEG files in a single album. When you select [AUDIO (MP3)] or [IMAGE (JPEG)], the system can recognize up to 600 MP3 and 600 JPEG files in a single album. A maximum of 200 albums can be recognized regardless of the selected mode.

Note

- You cannot playback JPEG files and MP3 tracks at the same time if they are not contained in the same album.
- When the JPEG image file's playback duration is longer than the MP3 audio track, the image slide show continues without sound.
- When the MP3 audio track is longer than the JPEG image file's playback duration, the audio track continues with no slide show.
- If there are no MP3 audio tracks and JPEG image files in the DATA CD, the [No audio data] and [No image data] messages appear on the screen.
- If you set [MODE (MP3, JPEG)] to [IMAGE (JPEG)] on a disc that contains MP3 tracks only or [AUDIO (MP3)] on a disc that contains JPEG files only, you may not able to change the [MODE (MP3, JPEG)] setting.
- PICTURE NAVI does not work when [AUDIO (MP3)] is selected.

- If you play large MP3 track data and JPEG image data at the same time, the sound may skip. It is recommended that you set the MP3 bit rate to 128 kbps or lower when creating the file. If the sound still skips, then reduce the size of the JPEG file.

Specifying the slide show duration

(JPEG only)

When you play JPEG image files using slide show, you can specify the duration for slides to appear on the screen.

1 Press \square DISPLAY twice.

The Control Menu for JPEG appears.

2 Press \uparrow/\downarrow to select [INTERVAL], then press ENTER.

The options for [INTERVAL] appear.

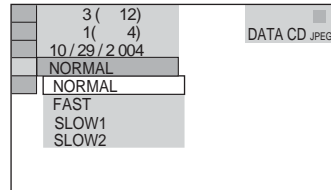

3 Press \uparrow/\downarrow to select the setting you want.

The default setting is underlined.

- [NORMAL]: sets the duration to about 6 to 9 seconds. (Images that are four million pixels or more will lengthen the duration.)
- [FAST]: sets the duration shorter than [NORMAL].
- [SLOW1]: Sets the duration longer than [NORMAL].
- [SLOW2]: Sets the duration longer than [SLOW1].

4 Press ENTER.

The selected setting takes effect.

Note

- Some JPEG files may take longer to display than others, which may make the duration seems longer than the option you selected. Especially progressive JPEG files or JPEG files of 3,000,000 pixels or more.

Selecting an effect for image files in the slide show

(JPEG only)

When you play a JPEG image file, you can select the effect to be used when viewing the slide show.

1 Press **DISPLAY** twice.

The Control Menu for JPEG appears.

2 Press to select [EFFECT], then press **ENTER**.

The options for [EFFECT] appear.

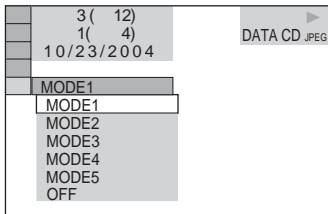

3 Press to select the setting you want.

The default setting is underlined.

- [MODE1]: The image sweeps in from top to bottom.
- [MODE2]: The image stretches out from left to right of the screen.
- [MODE3]: The image stretches out from the center of the screen.
- [MODE4]: The images randomly cycle through the effects.
- [MODE5]: The next image slides over the previous image.
- [OFF]: Turns off this function.

4 Press **ENTER**.

The selected setting takes effect.

Adjusting the Delay Between the Picture and Sound

(A/V SYNC)



When the sound does not match the pictures on the screen, you can adjust the delay between the picture and sound.

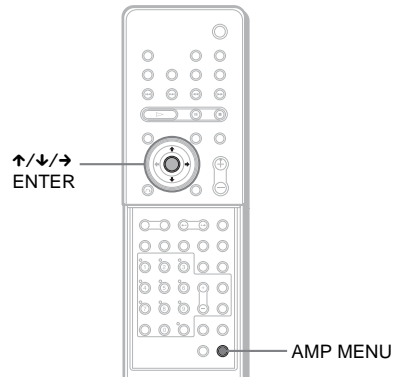

With cover opened.

1 Press **AMP MENU**.

2 Press repeatedly until "A/V SYNC" appears in the front panel display, then press **ENTER** or .

3 Press to select the setting.

- SYNC OFF: does not adjust.
- SYNC ON: adjusts the difference between picture and sound.

4 Press **ENTER** or **AMP MENU**.

The AMP menu turns off.

Note

- Depending on the input stream, this function may not be effective.
- Depending on the sound field, this function may not be effective.

Searching for a Particular Point on a Disc

(Scan, Slow-motion Play, Freeze Frame)



You can quickly locate a particular point on a disc by monitoring the picture or playing back slowly.

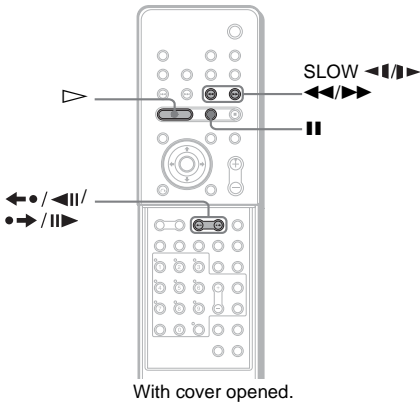

Note

- Depending on the DVD/VIDEO CD, you may not be able to do some of the operations described.

Locating a point quickly by playing a disc in fast forward or fast reverse (Scan) (except for JPEG)

Press **◀◀** or **▶▶** while playing a disc. When you find the point you want, press **▷** to return to normal speed. Each time you press **◀◀** or **▶▶** during scan, the playback speed changes. With each press the indication changes as shown below. Actual speeds may differ with some discs.

Playback direction

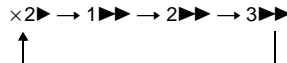

- 3▶▶▶ (DVD VIDEO/DVD-RW/VIDEO CD only)
- ×2▶▶ (DVD VIDEO/Super Audio CD/CD only)

Opposite direction

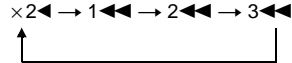

- 3◀◀◀ (DVD VIDEO/DVD-RW/VIDEO CD only)
- ×2◀◀ (DVD VIDEO only)

The “×2▶▶”/“×2◀◀” playback speed is about twice the normal speed. The “3▶▶▶”/“3◀◀◀” playback speed is faster than the “2▶▶▶”/“2◀◀◀” and the “2▶▶▶”/“2◀◀◀” playback speed is faster than “1▶▶▶”/“1◀◀◀”.

Watching frame by frame (Slow-motion Play)

(DVD, DVD-RW, VIDEO CD only)

Press **◀◀◀** or **▶▶▶** when the system is in pause mode. To return to the normal playback speed, press **▷**. Each time you press **◀◀◀** or **▶▶▶** during Slow-motion Play, the playback speed changes. Two speeds are available. With each press the indication changes as follows:

Playback direction

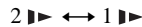

Opposite direction (DVD VIDEO only)

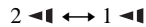

The “2▶▶”/“2◀◀” playback speed is slower than “1▶▶”/“1◀◀”.

Playing one frame at a time (Freeze Frame)

(except for Super Audio CD, CD, and JPEG)

When the system is in the pause mode, press **◀◀/▶▶** (step) to go to the next frame. Press **▶▶/◀◀** (step) to go to the preceding frame (DVD VIDEO/DVD-RW only). To return to normal playback, press **▷**.

continued

Note

- You cannot search for a still picture on a DVD-RW in VR mode.

Searching for a Title/ Chapter/Track/Scene, etc.



You can search a DVD by title or chapter, and you can search a VIDEO CD/Super Audio CD/CD/DATA CD by track, index, or scene. As titles and tracks are assigned unique numbers on the disc, you can select the desired one by entering its number. Or, you can search for a scene using the time code.

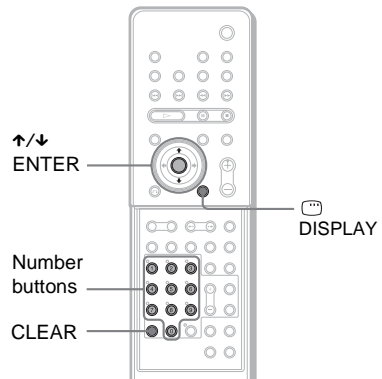

With cover opened.

- 1 Press **DISPLAY**. (When playing a **DATA CD with JPEG image files**, press **DISPLAY** twice.)

The Control Menu appears.

- 2 Press to select the search method.

■ **When playing a DVD VIDEO/DVD-RW**

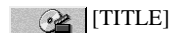

[TITLE]

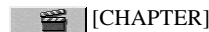

[CHAPTER]



[TIME/TEXT]

Select [TIME/TEXT] to search for a starting point by inputting the time code.

■ **When playing a VIDEO CD/Super VCD without PBC Playback**



[TRACK]



■ When playing a VIDEO CD/Super VCD with PBC Playback



■ When playing a Super Audio CD



■ When playing a CD



■ When playing a DATA CD (MP3 audio)



■ When playing a DATA CD (JPEG file)



Example: when you select [CHAPTER]

[** (**)] is selected (** refers to a number).

The number in parentheses indicates the total number of titles, chapters, tracks, indexes, scenes, albums or files.

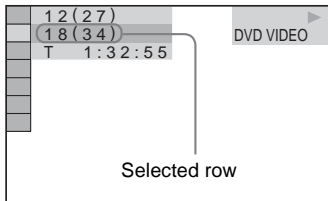

3 Press ENTER.

[** (**)] changes to [-- (**)].

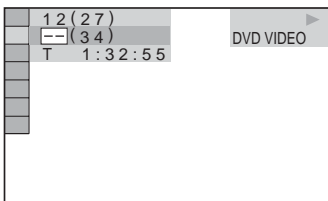

4 Press ↑/↓ or the number buttons to select the title, chapter, track, index, scene, etc., number you want to search for.

If you make a mistake

Cancel the number by pressing CLEAR, then select another number.

5 Press ENTER.

The system starts playback from the selected number.

To search for a scene using the time code (DVD VIDEO only)

1 In Step 2, select [TIME/TEXT].

[T **:**:**] (playing time of the current title) is selected.

2 Press ENTER.

[T **:**:**] changes to [T --:--:--].

3 Input the time code using the number buttons, then press ENTER.

For example, to find the scene at 2 hours, 10 minutes, and 20 seconds after the beginning, just enter [2:10:20].

Tip

- When the Control Menu display is turned off, you can search for a chapter (DVD VIDEO/DVD-RW) or track (Super Audio CD/CD) by pressing the number buttons and ENTER.

Note

- You cannot search for a scene on a DVD+RW using the time code.
- The title, chapter or track number displayed is the same number recorded on the disc.

Searching by Scene

(Picture Navigation)



You can divide the screen into 9 subscreens and find the desired scene quickly.

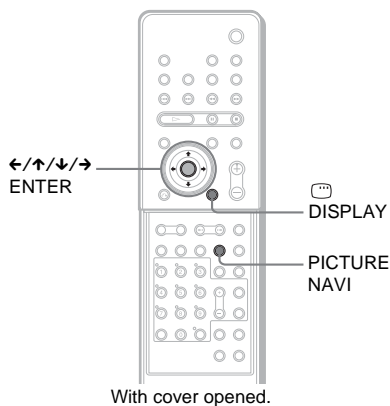

1 Press PICTURE NAVI during playback.

The following display appears.

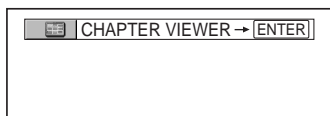

2 Press PICTURE NAVI repeatedly to select an item.

- [TITLE VIEWER] (DVD VIDEO only): displays the first scene of each title.
- [CHAPTER VIEWER] (DVD VIDEO only): displays the first scene of each chapter.
- [TRACK VIEWER] (VIDEO CD/ Super VCD only): displays the first scene of each track.

3 Press ENTER.

The first scene of each title, chapter, or track appears as follows.

1	2	3	▼
4	5	6	
7	8	9	

4 Press ←/↑/↓/→ to select a title, chapter, or track, and press ENTER.

Playback starts from the selected scene.

To return to normal play during setting

Press ⏪ RETURN or 📺 DISPLAY.

Tip

- If there are more than 9 titles, chapters, or tracks, ▼ is displayed at the bottom right of the screen. To display the additional titles, chapters, or tracks, select the bottom scenes and press ↓. To return to the previous scene, select the top scenes and press ↑.

Note

- Depending on the disc, you may not be able to select some items.

Viewing Information About the Disc

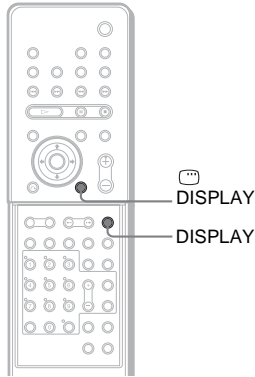

With cover opened.

Viewing the Playing Time and Remaining Time in the Front Panel Display

You can check disc information, such as the remaining time, total number of titles in a DVD, tracks in a VIDEO CD, Super Audio CD, CD, or MP3, using the front panel display (page 96).

Press DISPLAY.

Each time you press DISPLAY while playing the disc, the display changes as shown in the charts.

When playing a DVD VIDEO or DVD-RW

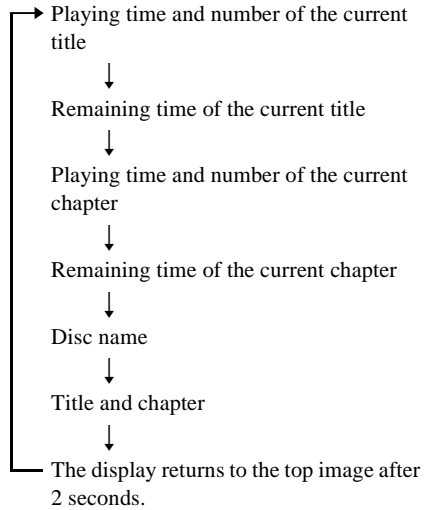

When playing a VIDEO CD (without PBC functions), Super Audio CD, or CD

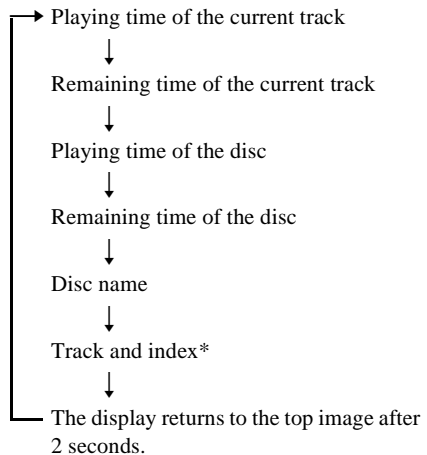

* Except for CD.

When playing an MP3

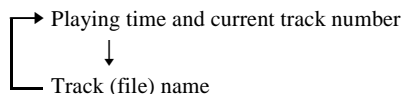

Tip

- When playing VIDEO CDs with PBC functions, the playing time is displayed.
- When playing VIDEO CDs without PBC functions, the track number and the index number are displayed after the Disc name.
- You can also check the time information and text using the Control Menu.

Note

- If the disc does not contain text, the Disc name or the Track (file) name is displayed “NO TEXT.”
- The system can only display the first level of the DVD/CD text, such as the Disc name or title.
- If an MP3 file name cannot be displayed, “*” will appear in the front panel display instead.
- The disc name or track name may not be displayed depending on the text.
- Playing time of MP3 audio tracks may not be displayed correctly.
- If you play a disc containing JPEG image files only and you set [MODE (MP3, JPEG)] to [AUTO] or [AUDIO (MP3)] (page 48), the “No Audio” message appears on the front panel display.
- If you play a disc containing MP3 files only and you set [MODE (MP3, JPEG)] to [IMAGE (JPEG)] (page 48), the “No Image” message appears on the front panel display.

Viewing the Station Name or Frequency in the front panel display

When the system is set to “TUNER AM” or “TUNER FM,” you can check the frequency using the front panel display.

Press DISPLAY.

Each time you press DISPLAY, the display changes as shown in the charts.

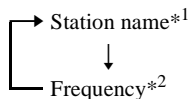

*1 This is displayed if you have entered a name for a preset station (page 74).

*2 Returns to the original display when several seconds has elapsed.

Checking the Playing Time and Remaining Time

You can check the playing time and remaining time of the current title, chapter, or track, and the total playing time or remaining time of the disc. You can also check the DVD text and MP3 folder name/file name recorded on the disc.

1 Press DISPLAY during playback.

The following display appears.

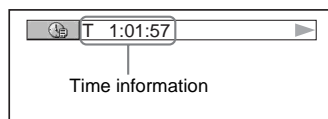
**2 Press DISPLAY repeatedly to change the time information.**

The display and the kinds of time that you can check depend on the disc you are playing.

■ When playing a DVD VIDEO or DVD-RW

- T *.*:*.**
Playing time of the current title
- T_*.**:*.**
Remaining time of the current title
- C *.*:*.**
Playing time of the current chapter
- C_*.**:*.**
Remaining time of the current chapter

■ When playing a VIDEO CD (with PBC functions)

- *.*:*.**
Playing time of the current scene

■ When playing a VIDEO CD (without PBC functions), Super Audio CD, or CD

- T *.*:*.**
Playing time of the current track
- T_*.**:*.**
Remaining time of the current track
- D *.*:*.**
Playing time of the current disc
- D_*.**:*.**
Remaining time of the current disc

■ When playing a DATA CD (MP3 audio)

- T **:.**

Playing time of the current track

Note

- Only alphabetical letters and numbers can be displayed.
- Depending on the type of disc being played, the system can only display a limited number of characters. Also, depending on the disc, not all text characters will be displayed.

Checking the play information of the Disc

To check DVD/Super Audio CD/CD text

Press DISPLAY repeatedly in Step 2 to display text recorded on the DVD/Super Audio CD/CD. The DVD/Super Audio CD/CD text appears only when text is recorded in the disc. You cannot change the text. If the disc does not contain text, "NO TEXT" appears.

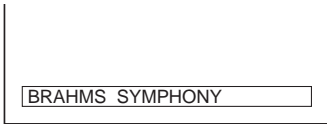

To check DATA CD (MP3 audio) text

By pressing DISPLAY while playing MP3 audio tracks on a DATA CD, you can display the name of the album/track, and the audio bit rate (the amount of data per second of the current audio) on your TV screen.

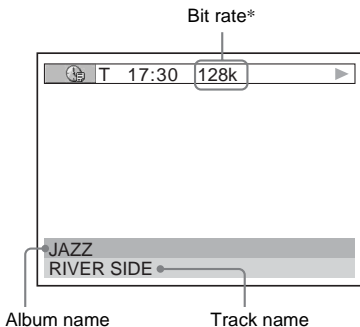

- * Appears when:
 - playing an MP3 audio track on DATA CDs.

Checking the date information (JPEG only)

You can check the date information during playback when the Exif* tag is recorded in the JPEG image data.

Press **DISPLAY twice during playback.**

The Control Menu appears.

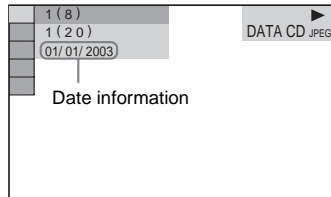

- * "Exchangeable Image File Format" is a digital camera image format defined by the Japan Electronics and Information Technology Industries Association (JEITA).

Tip

- Date information is [MM/DD/YYYY].
MM: Month
DD: Day
YYYY: Year

Note

- If there is no date information or data is damaged on the disc, the system cannot display the date information.

Sound Adjustments

Changing the Sound



When playing a DVD VIDEO recorded in multiple audio formats (PCM, Dolby Digital or DTS), you can change the audio format. If the DVD VIDEO is recorded with multilingual tracks, you can also change the language. With VIDEO CDs, CDs, or DATA CDs, you can select the sound from the right or left channel and listen to the sound of the selected channel through both the right and left speakers. For example, when playing a disc containing a song with the vocals on the right channel and the instruments on the left channel, you can hear the instruments from both speakers by selecting the left channel.

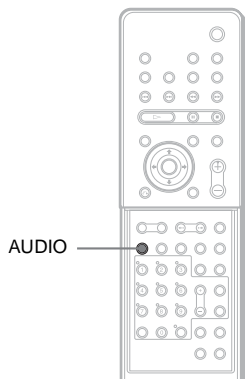

With cover opened.

1 Press **AUDIO** during playback.

The following display appears.

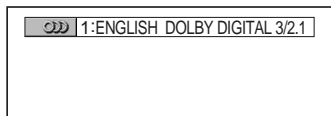

2 Press **AUDIO** repeatedly to select the desired audio signal.

■ When playing a DVD VIDEO

Depending on the DVD VIDEO, the choice of language varies.

When 4 digits are displayed, they indicate a language code. Refer to “Language Code List” (page 94) to see which language the code represents. When the same language is displayed two or more times, the DVD VIDEO is recorded in multiple audio formats.

■ When playing a DVD-RW

The audio streams recorded on a disc are displayed. The default setting is underlined. Example:

- [1: AUDIO]
- [2: AUDIO]

Note

- [2: AUDIO] does not appear when one audio stream is recorded on the disc.

■ When playing a VIDEO CD, CD, or DATA CD (MP3 audio)

The default setting is underlined.

- [STEREO]: the standard stereo sound
- [1/L]: the sound of the left channel (monaural)
- [2/R]: the sound of the right channel (monaural)

■ When playing a Super VCD

The default setting is underlined.

- [1:STEREO]: the stereo sound of the audio track 1
- [1:1/L]: the sound of the left channel of the audio track 1 (monaural)
- [1:2/R]: the sound of the right channel of the audio track 1 (monaural)
- [2:STEREO]: the stereo sound of the audio track 2
- [2:1/L]: the sound of the left channel of the audio track 2 (monaural)
- [2:2/R]: the sound of the right channel of the audio track 2 (monaural)

Note

- While playing a Super VCD on which the audio track 2 is not recorded, no sound will come out when you select [2:STEREO], [2:1/L], or [2:2/R].
- You cannot change the sound for Super Audio CDs.

Checking the audio signal format

(DVD only)

If you press AUDIO repeatedly during playback, the format of the current audio signal (PCM, Dolby Digital, DTS, etc.) appears as shown below.

■ When playing a DVD VIDEO

Example:

Dolby Digital 5.1 ch

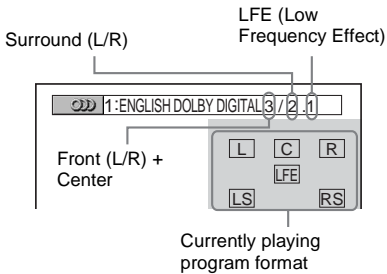

Example:

Dolby Digital 3 ch

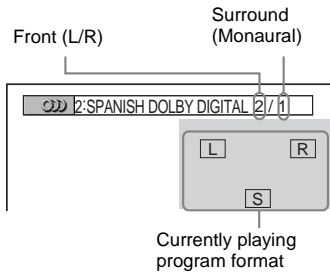

About audio signals

Audio signals recorded in a disc contain the sound elements (channels) shown below. Each channel is output from a separate speaker.

- Front (L)
- Front (R)
- Center
- Surround (L)
- Surround (R)
- Surround (Monaural): This signal can be either the Dolby Surround Sound processed signals

or the Dolby Digital sound's monaural Surround audio signals.

- LFE (Low Frequency Effect) signal

Enjoying Surround Sound by Using Sound Field



You can take advantage of surround sound simply by selecting one of system's pre-programmed sound fields. They bring the exciting and powerful sound of movie theaters into your home.

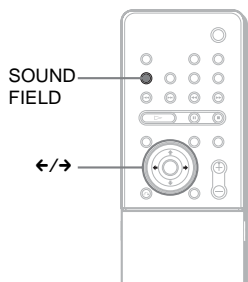

Press SOUND FIELD.

Each time you press SOUND FIELD repeatedly until the sound field you want appears in the front panel display.

You can also select the sound field by pressing ←/→.

All sound field

Sound field	Display
AUTO FORMAT DIRECT AUTO	A.F.D. AUTO
Dolby Pro Logic	PRO LOGIC
Dolby Pro Logic II MOVIE	PLII MOVIE
Dolby Pro Logic II MUSIC	PLII MUSIC
CINEMA STUDIO EX A	C. ST. EX A*
CINEMA STUDIO EX B	C. ST. EX B*
CINEMA STUDIO EX C	C. ST. EX C*
MULTI ST.	MULTI ST.
REAR ST.	REAR ST.
HALL	HALL
JAZZ CLUB	JAZZ CLUB
LIVE CONCERT	L. CONCERT
GAME	GAME
SPORTS	SPORTS

Sound field	Display
MONO MOVIE	MONO MOVIE
NIGHT	NIGHT
2 CHANNEL STEREO	2CH STEREO
HEADPHONE THEATER	HP THEATER
HEADPHONE 2CHANNEL STEREO	HP 2CH STEREO

*Use DCS Technology

Automatic outputting of the original sound

■ AUTO FORMAT DIRECT AUTO

The auto decoding function automatically detects the type of audio signal being input (Dolby Digital, DTS, or standard 2 channel stereo) and performs the proper decoding if necessary. This mode presents the sound as it was recorded/encoded, without adding any effects (e.g. reverberation).

However, if there are no low frequency signals (Dolby Digital LFE, etc.), it will generate a low frequency signal for output to the subwoofer.

Using only the front speaker and subwoofer

■ 2 CHANNEL STEREO

This mode outputs the sound from the front left and right speakers and subwoofer. Standard 2 channel (stereo) sources completely bypass the sound field processing. Multi channel surround formats are downmixed to two channels.

This allows you to play any source using only the front left and right speakers and subwoofer.

Outputting 2 channel sources like CDs by 5.1channel

■ Dolby Pro Logic

Dolby Pro Logic produces five output channels from 2 channel sources. This mode performs Pro Logic decoding to the input signal and output to front, center, and surround speakers.

Meanwhile, the surround channel becomes monaural.

■ Dolby Pro Logic II MOVIE/MUSIC

Dolby Pro Logic II produces five full-bandwidth output channels from 2 channel sources. This is done using an advanced, high-purity matrix surround decoder that extracts the spatial properties of the original recording without adding any new sounds or tonal colorations.

Note

- When the input signal is multi channel source, Dolby Pro Logic and Dolby Pro Logic II MOVIE/MUSIC are canceled and the multi channel source is output directly.
- When the bilingual broadcast sound is input, Dolby Pro Logic and Dolby Pro Logic II MOVIE/MUSIC are not effective.

Enjoying Digital Cinema Sound

About DCS (Digital Cinema Sound)

In collaboration with Sony Pictures Entertainment, Sony measured the sound environment of their studios and integrated the data of the measurement and Sony's own DSP (Digital Signal Processor) technology to develop "Digital Cinema Sound." "Digital Cinema Sound" simulates in a home theater an ideal movie theater sound environment based on the preference of the movie director.

■ CINEMA STUDIO EX A (Cinema Studio EX A)

Reproduces the sound characteristics of the Sony Pictures Entertainment "Cary Grant Theater" cinema production studio. This is a standard mode, great for watching most any type of movie.

■ CINEMA STUDIO EX B (Cinema Studio EX B)

Reproduces the sound characteristics of the Sony Pictures Entertainment "Kim Novak Theater" cinema production studio. This mode is ideal for watching science-fiction or action movies with lots of sound effects.

■ CINEMA STUDIO EX C (Cinema Studio EX C)

Reproduces the sound characteristics of the Sony Pictures Entertainment scoring stage. This

mode is ideal for watching musicals or classic films where music is featured in the soundtrack.

About Cinema Studio EX

Cinema Studio EX is ideal for enjoying the movie software encoded with multi channel format, such as the Dolby Digital DVD. This mode reproduces the sound characteristics of Sony Pictures Entertainment's studios. Cinema Studio EX consists of the following 3 elements.

- **Virtual Multi Dimension**
Creates 5 sets of virtual speakers surrounding the listener from a single pair of actual surround speakers.
- **Screen Depth Matching**
In a movie theater, sound seems to come from inside the image reflected on the movie screen. This element creates the same sensation in your listening room by shifting the sound of the front speakers "into" the screen.
- **Cinema Studio Reverberation**
Reproduces the reverberations peculiar to a movie theater. Cinema Studio EX is the integrated mode which operates these elements simultaneously.

Note

- The virtual speaker effect may cause increased noise in the playback signal.
- When listening with sound fields that employ virtual speakers, you will not be able to hear any sound coming directly from the surround speakers.

Outputting 2 channel sources from the surround speakers and center speaker

■ MULTI ST.

This mode outputs 2 channel sources from the front speakers, surround speakers, and center speaker simultaneously. The sound that is output from the surround speakers is same as the sound that is output from the front speakers.

■ REAR ST.

This mode outputs 2 channel sources from the surround speakers only. (Although no sound is output from the front speakers, sound is output from the front speakers when you set

[SURROUND] in [SPEAKER SETUP] to [NONE] (page 82.)

Tip

- When you select “MULTI ST.” or “REAR ST.,” “LINK” lights up in the front panel display.

Selecting a sound field for movies, music, news, sports, or others

■ HALL, JAZZ CLUB, LIVE CONCERT, GAME, SPORTS, MONO MOVIE

The each mode provided sound to suit the source.

Enjoying the sound at low volume

■ NIGHT

You can enjoy sound effects or dialogue, as you would in a movie theater, even at low volume. It is useful for watching movies at night.

Enjoying the surround sound by headphones

■ HEADPHONE THEATER

This mode outputs the sound as surround from headphone L/R.

■ HEADPHONE 2CHANNEL STEREO

This mode outputs the sound from headphone L/R. Standard 2 channel (stereo) sources completely bypass the sound field processing. Multi channel surround formats are downmixed to two channels.

To turn the surround effect off

Press SOUND FIELD repeatedly until “A.F.D. AUTO” or “2CH STEREO” appears in the front panel display.

Tip

- The system memorizes the last sound field selected for each function mode. Whenever you select a function such as DVD or TUNER, the sound field that was last applied to function is automatically applied again. For example, if you listen to DVD with HALL as the sound field, then change to another function, and then return to DVD, HALL will be applied again.

Enjoying TV or VCR Sound from All Speakers

You can enjoy TV or VCR sound from all speakers of this system.

For details, see “Step 3: TV Hookup” (page 25) and “Step 4: Other Component Hookup” (page 30).

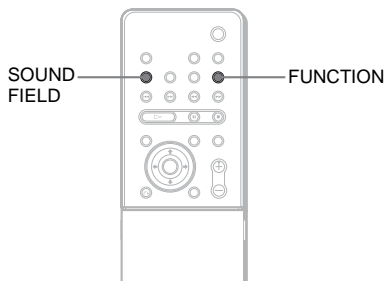

- 1 Press FUNCTION repeatedly until “VIDEO 1” or “VIDEO 2” (depending on connection) appears in the front panel display.**
- 2 Press SOUND FIELD repeatedly until the sound field you want appears in the front panel display.**

When you want to output the TV sound or stereo sound of a 2 channel source from the 6 speakers, select the “Dolby Pro Logic,” “Dolby Pro Logic II MOVIE,” or “Dolby Pro Logic II MUSIC” sound field.

Note

- When you use both the VIDEO 1 or VIDEO 2 jacks (analog connection) and COAXIAL DIGITAL IN or OPTICAL DIGITAL IN jack (digital connection) at the same time, the digital connection takes priority.

Using the Sound Effect

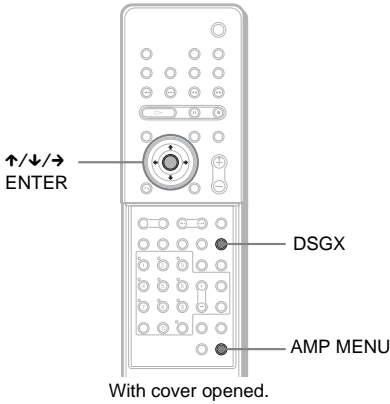

Reinforcing bass frequencies

You can reinforce bass frequencies.

Press DSGX.

Bass frequencies are effectively reinforced.

To turn off the sound effect

Press DSGX again.

Enjoying the sound at low volume

Narrows the dynamic range of the sound track.
Useful for watching movies at low volume late at night.

1 Press AMP MENU.

2 Press ↓/↑ repeatedly until “AUDIO DRC” appears in the front panel display, then press ENTER or →.

3 Press ↓/↑ to select the setting.

- DRC STD: reproduces the sound track with the kind of dynamic range that the recording engineer intended.
- DRC MAX: compresses dynamic range fully.
- DRC OFF: no compression of dynamic range.

4 Press ENTER or AMP MENU.

The AMP menu turns off.

Note

- AUDIO DRC only applies to Dolby Digital sources.

Using Various Additional Functions

Changing the Angles

DVD-V

If various angles (multi-angles) for a scene are recorded on a DVD VIDEO, you can change the viewing angle.

For example, while playing a scene of a train in motion, you can display the view from either the front of the train, the left window of the train, or from the right window without having the train's movement interrupted.

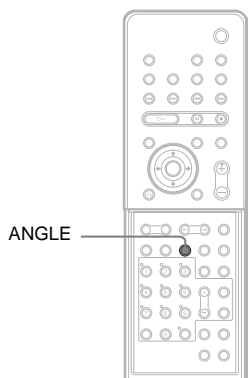

With cover opened.

Press ANGLE during playback.

Each time you press ANGLE, the angle changes.

Note

- Depending on the DVD VIDEO, you may not be able to change the angle even if multi-angles are recorded on the DVD VIDEO.

Displaying the Subtitles

DVD-V

DVD-RW

If subtitles are recorded on a disc, you can turn the subtitles on or off while playing. If multilingual subtitles are recorded on the disc, you can change the subtitle language while playing, or turn the subtitles on or off whenever you want. You can select a language you are learning, for example, and turn on the subtitles for better understanding.

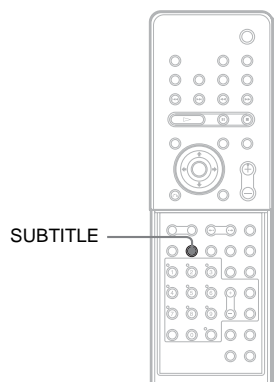

With cover opened.

Press SUBTITLE during playback.

Each time you press SUBTITLE, the subtitle language changes.

Note

- Depending on the DVD VIDEO, you may not be able to change the subtitles even if multilingual subtitles are recorded on it. You also may not be able to turn them off.

Locking Discs

(CUSTOM PARENTAL CONTROL, PARENTAL CONTROL)



You can set 2 kinds of playback restrictions for the desired disc.

- Custom Parental Control
You can set playback restrictions so that the system will not play inappropriate discs.
- Parental Control
Playback of some DVD VIDEOS can be limited according to a predetermined level such as the age of the users. Scenes may be blocked or replaced with different scenes. The same password is used for both Custom Parental Control and Parental Control.

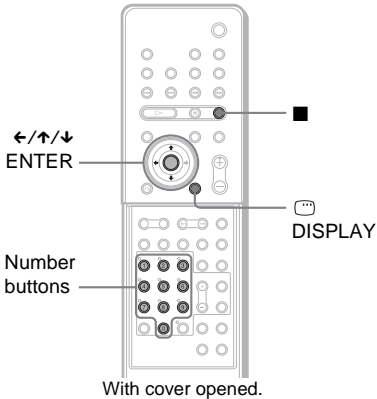

Preventing playback of specific discs [CUSTOM PARENTAL CONTROL]

You can set the same Custom Parental Control password for up to 40 discs. When you set the 41st-disc, the first disc is canceled.

- 1 Insert the disc you want to lock.**
If the disc is playing, press ■ to stop playback.
- 2 Press [DISPLAY] while the system is in stop mode.**
The Control Menu appears.

- 3 Press ↑/↓ to select [PARENTAL CONTROL], then press ENTER.**

The options for [PARENTAL CONTROL] appear.

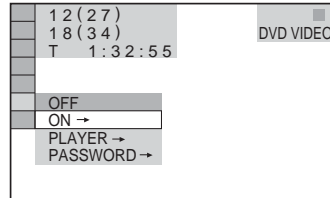

- 4 Press ↑/↓ to select [ON →], then press ENTER.**

■ **If you have not entered a password**
The display for registering a new password appears.

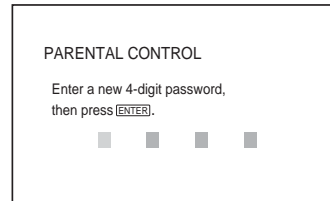

Enter a 4-digit password using the number buttons, then press ENTER.
The display for confirming the password appears.

■ **When you have already registered a password**
The display for entering the password appears.

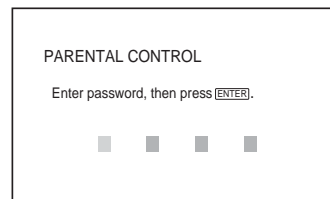

- 5 Enter or re-enter your 4-digit password using the number buttons, then press ENTER.**

[Custom parental control is set.] appears and the screen returns to the Control Menu.

To turn off the Custom Parental Control function

- 1 Follow steps 1 through 3 of "Preventing playback of specific discs [CUSTOM PARENTAL CONTROL]."
- 2 Press **↑/↓** to select [OFF →], then press ENTER.
- 3 Enter your 4-digit password using the number buttons, then press ENTER.

To play a disc for which Custom Parental Control is set

- 1 Insert the disc for which Custom Parental Control is set.
The [CUSTOM PARENTAL CONTROL] display appears.

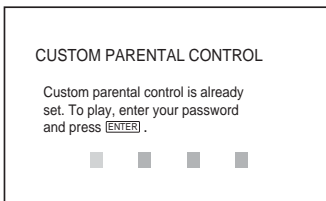

- 2 Enter your 4-digit password using the number buttons, then press ENTER.
The system is ready for playback.

Tip

- If you forget your password, enter the 6-digit number "199703" using the number buttons when the [CUSTOM PARENTAL CONTROL] display asks you for your password, then press ENTER. The display will ask you to enter a new 4-digit password.

Limiting playback for children [PARENTAL CONTROL]

(DVD only)

Playback of some DVD VIDEOS can be limited according to a predetermined level such as the age of the users. The [PARENTAL CONTROL] function allows you to set a playback limitation level.

- 1 Press **DISPLAY** while the system is in stop mode.
The Control Menu appears.

- 2 Press **↑/↓** to select **[PARENTAL CONTROL]**, then press ENTER.

The options for [PARENTAL CONTROL] appear.

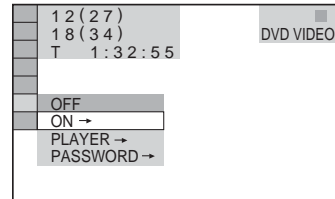

- 3 Press **↑/↓** to select **[PLAYER →]**, then press ENTER.

■ If you have not entered a password
The display for registering a new password appears.

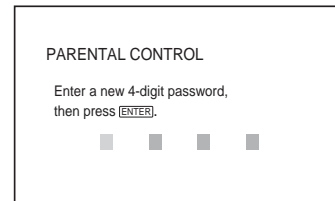

Enter a 4-digit password using the number buttons, then press ENTER.

The display for confirming the password appears.

■ When you have already registered a password

The display for entering the password appears.

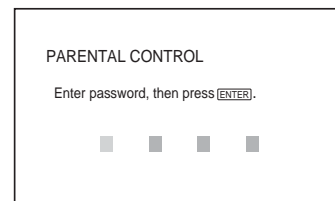

- 4 Enter or re-enter your 4-digit password using the number buttons, then press ENTER.

The display for setting the playback limitation level appears.

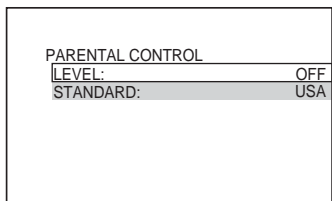

5 Press \uparrow/\downarrow to select [STANDARD], then press ENTER.

The selection items for [STANDARD] are displayed.

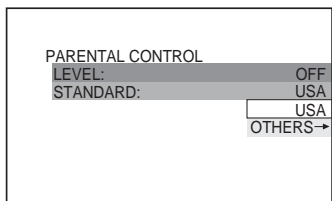

6 Press \uparrow/\downarrow to select a geographic area as the playback limitation level, then press ENTER.

The area is selected.

When you select [OTHERS →], select and enter a standard code in the table on page 68 using the number buttons.

7 Press \uparrow/\downarrow to select [LEVEL], then press ENTER.

The selection items for [LEVEL] are displayed.

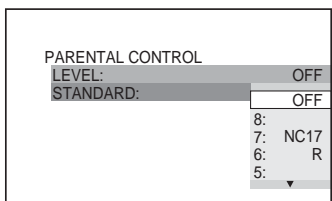

8 Press \uparrow/\downarrow to select the level you want, then press ENTER.

Parental Control setting is complete.

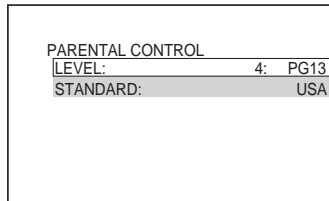

The lower the value, the stricter the limitation.

To turn off the Parental Control function

Set [LEVEL] to [OFF] in Step 8.

To play a disc for which Parental Control is set

1 Insert the disc and press \triangleright .

The display for entering your password appears.

2 Enter your 4-digit password using the number buttons, then press ENTER.

The system starts playback.

Tip

- If you forget your password, remove the disc and repeat steps 1 to 3 of “Preventing playback of specific discs [CUSTOM PARENTAL CONTROL].” When you are asked to enter your password, enter “199703” using the number buttons, then press ENTER. The display will ask you to enter a new 4-digit password. After you enter a new 4-digit password, replace the disc in the system and press \triangleright . When the display for entering your password appears, enter your new password.

Note

- The Control Menu display will show different items depending on the disc type.
- When you play discs which do not have the Parental Control function, playback cannot be limited on this system.
- Depending on the disc, you may be asked to change the parental control level while playing the disc. In this case, enter your password, then change the level. If the Resume Play mode is canceled, the level returns to the previous level.

Area Code

Standard	Code number	Standard	Code number
Argentina	2044	Malaysia	2363
Australia	2047	Mexico	2362
Austria	2046	Netherlands	2376
Belgium	2057	New Zealand	2390
Brazil	2070	Norway	2379
Canada	2079	Pakistan	2427
Chile	2090	Philippines	2424
China	2092	Portugal	2436
Denmark	2115	Russia	2489
Finland	2165	Singapore	2501
France	2174	Spain	2149
Germany	2109	Sweden	2499
India	2248	Switzerland	2086
Indonesia	2238	Thailand	2528
Italy	2254	United Kingdom	2184
Japan	2276		
Korea	2304		

6 To confirm your password, re-enter it using the number buttons, then press ENTER.

If you make a mistake entering your password

Press ← before you press ENTER and input the correct number.

Changing the password

1 Press  DISPLAY while the system is in stop mode.

The Control Menu appears.

2 Press ↑/↓ to select  [PARENTAL CONTROL], then press ENTER.

The options for [PARENTAL CONTROL] appear.

3 Press ↑/↓ to select [PASSWORD →], then press ENTER.

The display for entering the password appears.

4 Enter your 4-digit password using the number buttons, then press ENTER.

5 Enter a new 4-digit password using the number buttons, then press ENTER.

Other Operations

Controlling the TV with the Supplied Remote

By adjusting the remote signal, you can control your TV with the supplied remote.

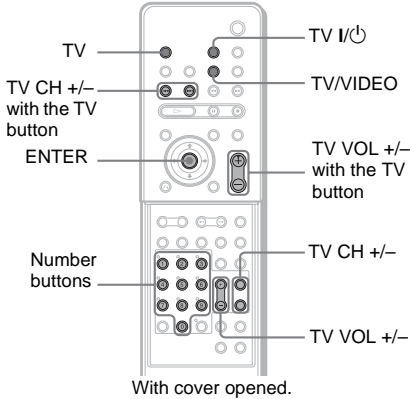

Note

- If you enter a new code number, the code number previously entered will be erased.
- When you replace the batteries of the remote, the code number may reset itself to the default (SONY) setting. Reset the appropriate code number.

Controlling TVs with the remote

Press and hold TV I/⏻ while entering your TV's manufacturer's code (see the table) using the number buttons. Then release TV I/⏻.

If you set successfully the manufacturer's code, the remote transmits the on/off signal of the TV.

Code numbers of controllable TVs

If more than one code number is listed, try entering them one at a time until you find the one that works with your TV.

TV

Manufacturer	Code number
SONY	001 (default)
DAEWOO	002, 004, 005, 006
FISHER	009
GOLDSTAR	020
HITACHI	014, 015
JVC	018
LOEWE	027, 028
MAGNAVOX	034
MITSUBISHI/MGA	022
PANASONIC	049, 050
PIONEER	029
RCA/PROSCAN	012, 032, 033
SAMSUNG	036
SANYO	010
SHARP	039, 040
TOSHIBA	046
ZENITH	016, 017

CATV

Manufacturer	Code number
SONY	101
HAMLIN/REGAL	123, 124, 125, 126, 127
JERROLD/GI	102, 103, 104, 105, 106, 107, 108, 109, 119
OAK	128, 129, 130
PANASONIC	120, 121, 122
PIONEER	115, 116
SCIENTIFIC ATLANTA	110, 111, 112
TOCOM	117, 118, 131
ZENITH	113, 114

To control the TV

You can control the TV by using following buttons.

By pressing	You can
TV I/⏻	Turn the TV on or off.
TV/VIDEO*	Switch the TV's input source between the TV and other input sources.
TV VOL +/-*	Adjust the TV volume.
TV CH +/-*	Select the TV channel.
Number buttons*	Select the TV channel.

continued

- * To use these buttons, set the remote to the TV mode by pressing the TV button. To cancel the TV mode, press the TV button again.

You can select the TV channels by using the number buttons.

To select the TV channels, press the number buttons, then ENTER.

Note

- Depending on the TV, you may not be able to control your TV or to use some of the buttons above.
- The TV mode turns off when you do not operate the remote for 10 seconds.

Using the THEATRE SYNC Function

THEATRE SYNC allows you to turn on your SONY TV and this system, changes the system mode to “DVD,” and then switches the TV’s input source you set with one button push.

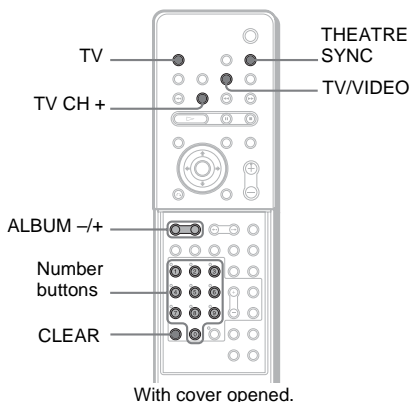

Preparing for the THEATRE SYNC function

Register the TV’s input source connected to this system.

Press and hold TV/VIDEO while entering the code for the TV’s input source connected to this system (see the table) using the number buttons.

The TV’s input source is selected.

If you successfully set the TV’s input source code, the TV button flashes twice slowly. If the setting is unsuccessful, the TV button flashes 5 times quickly.

Set your TV’s input to the input you used to connect the system. For details, see the instructions of your TV.

By pressing	Number	TV's input source
TV/VIDEO	0	No input source (Default)
	1	VIDEO1
	2	VIDEO2
	3	VIDEO3
	4	VIDEO4
	5	VIDEO5
	6	VIDEO6
	7	VIDEO7
	8	VIDEO8
	9*	COMPONENT 1 INPUT
	CLEAR*	COMPONENT 2 INPUT
	ALBUM -*	COMPONENT 3 INPUT
	ALBUM +*	COMPONENT 4 INPUT

* Except for North American models.

Operating for the THEATRE SYNC function

Point the remote to the direction of TV and this system, then press THEATRE SYNC once.

While transmitting the code from the remote, the TV button flashes.

If this function does not work, change the transmit time. The transmit time varies depending on the TV.

To change the transmit time

Press and hold TV CH + while entering the code for transmit time (see the table) using the number buttons.

The transmit time from the remote is selected. If you successfully set the transmit time code, the TV button flashes twice slowly. If the setting is unsuccessful, the TV button flashes 5 times quickly.

By pressing	Number	Transmit time
TV CH +	1	0.5 (Default)
	2	1
	3	1.5
	4	2

By pressing	Number	Transmit time
	5	2.5
	6	3
	7	3.5
	8	4

Note

- This function is only for SONY TVs. (This function may not work on some SONY TVs.)
- If distance between TV and this system is too far, this function may not work. Install the system near the TV.
- Keep the remote pointed in the direction of the TV and this system while the TV button is flashing.

Enjoying the Sound of Other Components

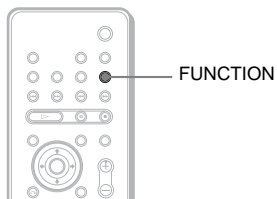

Selecting the connected component

You can use a VCR or other components connected to the VIDEO 1 or VIDEO 2 jacks on the rear panel. Refer to the operation manual supplied with the components for further information on the operation.

Press FUNCTION repeatedly until “VIDEO 1” or “VIDEO 2” appears in the front panel display.

Each time you press FUNCTION, the mode of the system changes in the following sequence.

DVD → TUNER FM → TUNER AM →
VIDEO 1 → VIDEO 2 → DVD → ...

Enjoying Multiplex Broadcast Sound

(DUAL MONO)

You can enjoy multiplex broadcast sound when the system receive the AC-3 multiplex broadcast signal.

Note

- To receive the AC-3 signal, you need to connect a digital satellite tuner to the system with an optical cable or coaxial cable (page 30) and set the digital output mode of the digital satellite tuner to AC-3.
- When you connect the system and TV with the HDMI cord, this function does not apply to the sound that is output from the TV. The main sound is output from the TV.

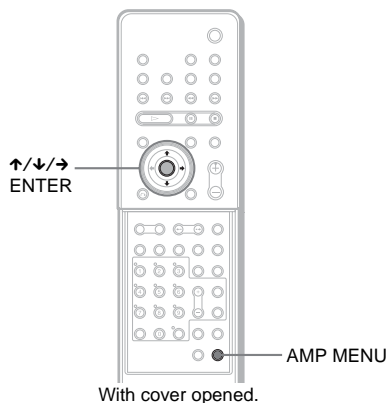

- 1 Press AMP MENU.**
- 2 Press ↓/↑ repeatedly until “DUAL MONO” appears in the front panel display, then press ENTER or →.**
- 3 Press ↓/↑ to select the sound you want.**
 - MAIN: main sound is output from the left and right speakers.
 - SUB: sub sound is output from the left and right speakers.
 - MAIN+SUB: main sound and Sub sound are output from the left and right speakers.

- MAIN/SUB: main sound is output from the left speaker and Sub sound is output from the right speaker.

4 Press ENTER or AMP MENU.

The AMP menu turns off.

Enjoying the Radio

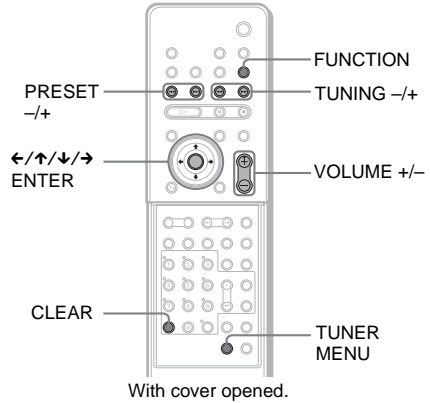

Presetting radio stations

You can preset 20 FM stations, and 10 AM stations. Before tuning, make sure to turn down the volume to minimum.

- 1 Press FUNCTION repeatedly until the band you want appears in the front panel display.**
- 2 Press and hold TUNING + or - until the auto scanning starts.**

Scanning stops when the system tunes in a station. "TUNED" and "ST" (for stereo program) appear in the front panel display.



- 3 Press TUNER MENU.**
- 4 Press </>/</>/</> repeatedly until "Memory?" appears in the front panel display.**
- 5 Press ENTER.**

A preset number appears in the front panel display.



continued

- 6** Press \uparrow/\downarrow to select the preset number you want.



- 7** Press ENTER.
The station is stored.



- 8** Repeat 1 to 7 to store other stations.

To change the preset number

Restart from Step 1.

To change the AM tuning interval (except for Middle Eastern model)

The AM tuning interval can be set to either 10 kHz or 9 kHz.

To change the AM tuning interval, first tune in any AM station, then turn off the system by pressing I/O on the system. While holding down $\blacktriangleright\blacktriangleright$ (on the system), press I/O on the system to turn on the power. If you change the interval, AM preset stations will be erased.

To reset the interval, repeat the same procedure.

Listening to the radio

Preset radio stations in the system's memory first (see "Presetting radio stations" (page 73)).

- 1** Press FUNCTION repeatedly until "FM" or "AM" appears in the front panel display.

The last received station is tuned in.

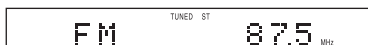

- 2** Press PRESET + or – repeatedly to select the preset station you want.

Each time you press the button, the system tunes in one preset station.

- 3** Adjust the volume by pressing VOLUME +/-.

To turn off the radio

Press I/O .

To listen to non-preset radio stations

Use manual or automatic tuning in Step 2.

For manual tuning, press TUNING + or – repeatedly.

For automatic tuning, press and hold TUNING + or –. Press \blacksquare when you stop the automatic tuning.

Tip

- If an FM program is noisy, press FM MODE so that "MONO" appears in the front panel display. There will be no stereo effect, but the reception will improve. Press the button again to restore the stereo effect.
- To improve reception, reorient the supplied antennas (aerials).
- You can check the frequency by pressing DISPLAY repeatedly (page 56).

Naming preset stations

You can enter a name for preset stations. These names (for example, "XYZ") appear in the system's front panel display when a station is selected.

Note that no more than one name can be entered for each preset station.

- 1** Press FUNCTION repeatedly until "FM" or "AM" appears in the front panel display.

The last station you received is tuned in.

- 2** Press PRESET + or – repeatedly to select the preset station you want to create an index name for.

- 3** Press TUNER MENU.

- 4** Press $\leftarrow/\uparrow/\downarrow/\rightarrow$ repeatedly until "Name In?" appears in the front panel display.

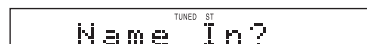

- 5** Press ENTER.

- 6** Create a name by using the cursor buttons.

Press \uparrow/\downarrow to select a character, then press \rightarrow to move the cursor to the next position.

Letters, numbers, and other symbols can be input for a radio station name.

If you make a mistake

Press \leftarrow/\rightarrow repeatedly until the character to be changed flashes, then press \uparrow/\downarrow to select the desired character.

To erase the character, press \leftarrow/\rightarrow repeatedly until the character to be erased flashes, then press CLEAR.

7 Press ENTER.

The station name is stored.

Using the Sleep Timer

You can set the system to turn off at a preset time, so you can fall asleep listening to music.

You can preset the time in 10 minutes decrements.

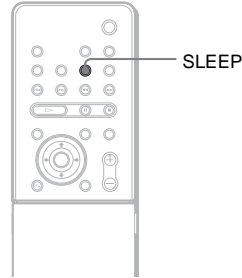

Press SLEEP.

Each time you press this button, the minutes display (the remaining time) changes as follows:

SLEEP 90M \rightarrow SLEEP 80M \rightarrow SLEEP 70M
 \uparrow \downarrow
SLEEP OFF \leftarrow SLEEP 10M SLEEP 60M

To check the remaining time

Press SLEEP once.

To change the remaining time

Press SLEEP repeatedly to select the desired time.

To cancel the Sleep Timer function

Press SLEEP repeatedly until "SLEEP OFF" appears in the front panel display.

Changing the Brightness of the Front Panel Display

The brightness of the front panel display can be set to either of 2 levels.

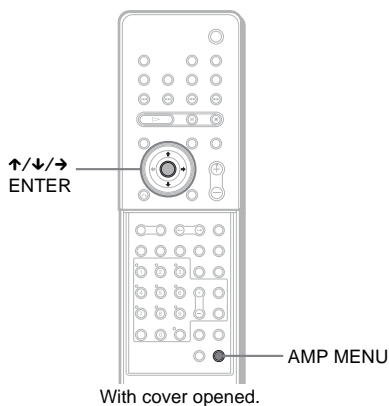

- 1 Press AMP MENU.**
- 2 Press \uparrow/\downarrow repeatedly until "DIMMER" appears in the front panel display, then press ENTER or \rightarrow .**
- 3 Press \uparrow/\downarrow to select the brightness of the front panel display.**
- 4 Press ENTER or AMP MENU.**
The AMP menu turns off.

Returning to the Default Settings

You can return the system parameters, such as preset stations, to the default settings.

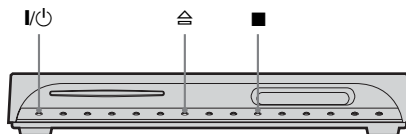

- 1 Press I/Power to turn on the system.**
- 2 Press \blacksquare , Home, and I/Power on the system at the same time.**
"COLD RESET" appears in the front panel display and the default settings are returned.

Settings and Adjustments

Using the Setup Display

By using the Setup Display, you can make various adjustments to items such as picture and sound. You can also set a language for the subtitles and the Setup Display, among other things. For details on each Setup Display item, see pages from 78 to 84. For an overall list of Setup Display items, see page 100.

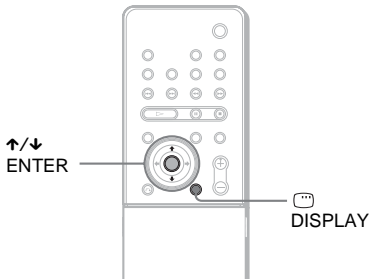

Note

- Playback settings stored in the disc take priority over the Setup Display settings and not all the functions described may work.





- 1 Press  DISPLAY when the system is in stop mode.**

The Control Menu appears.

- 2 Press  to select  [SETUP], then press ENTER.**

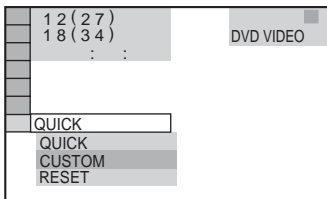
The options for [SETUP] appear.



- 3 Press  to select [CUSTOM], then press ENTER.**

The Setup Display appears.

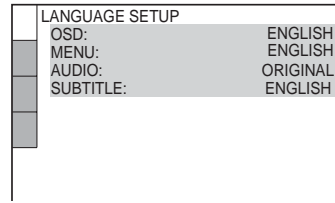



- 4 Press  to select the setup item from the displayed list: [LANGUAGE SETUP], [SCREEN SETUP], [CUSTOM SETUP], or [SPEAKER SETUP]. Then press ENTER.**

The Setup item is selected.

Example: [SCREEN SETUP]

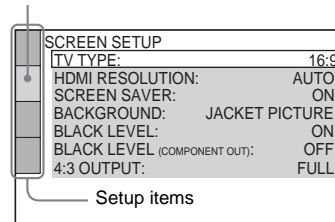
Selected item



- 5 Select an item using , then press ENTER.**

The options for the selected item appear.

Example: [TV TYPE]

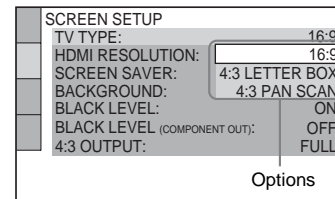

- 6 Select a setting using , then press ENTER.**

The setting is selected and setup is complete.

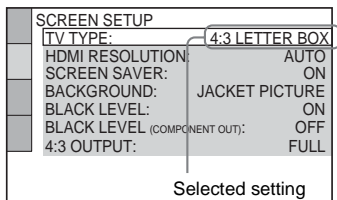

To reset all of the [SETUP] settings

- 1 Select [RESET] in Step 3 and press ENTER.
- 2 Select [YES] using \uparrow/\downarrow .
- 3 Press ENTER.

You can also quit the process and return to the Control Menu by selecting [NO] here.

All the settings explained on pages 78 to 84 return to the default settings. Do not press \mathbf{I}/\mathbf{O} while resetting the system as it takes a few seconds to complete.

Note

- When you turn the system on after resetting and no disc is in the system, the guide message appears on the TV screen. To perform the Quick Setup (page 33), press ENTER, to return to normal screen, press CLEAR.

Setting the Display or Sound Track Language

[LANGUAGE SETUP]

[LANGUAGE SETUP] allows you to set various languages for the on-screen display or sound track.

Select [LANGUAGE SETUP] in the Setup Display. To use the display, see “Using the Setup Display” (page 77).

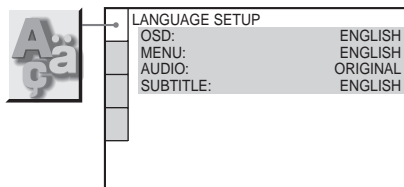

■ [OSD] (On-Screen Display)

Switches the display language on the screen.

■ [MENU] (DVD VIDEO only)

You can select the desired language for the disc’s menu.

■ [AUDIO] (DVD VIDEO only)

Switches the language of the sound track. When you select [ORIGINAL], the language given priority in the disc is selected.

■ [SUBTITLE] (DVD VIDEO only)

Switches the language of the subtitle recorded on the DVD VIDEO.

When you select [AUDIO FOLLOW], the language for the subtitles changes according to the language you selected for the sound track.

Tip

- If you select [OTHERS \rightarrow] in [MENU], [AUDIO], and [SUBTITLE], select and enter a language code from “Language Code List” (page 94) using the number buttons.

Note

- When you select a language in [MENU], [AUDIO], or [SUBTITLE] that is not recorded on the DVD VIDEO, one of the recorded languages will be automatically selected (depending on the disc, the language may not be selected automatically).

Settings for the Display

[SCREEN SETUP]

Choose settings according to the TV to be connected.

Select [SCREEN SETUP] in the Setup Display. To use the display, see “Using the Setup Display” (page 77).

The default settings are underlined.

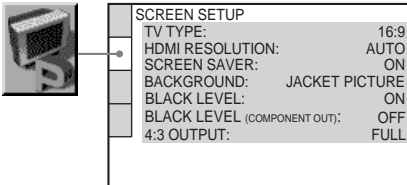

■ [TV TYPE]

Selects the aspect ratio of the connected TV (4:3 standard or wide).

The default setting varies, depending on the country model.

[4:3 LETTER BOX]

Select this when you connect a 4:3 screen TV. Displays a wide picture with bands on the upper and lower portions of the screen.

[4:3 PAN SCAN]

Select this when you connect a 4:3 screen TV. Automatically displays the wide picture on the entire screen and cuts off the portions that do not fit.

[16:9]

Select this when you connect a wide-screen TV or a TV with a wide mode function.

[4:3 LETTER BOX]



[4:3 PAN SCAN]

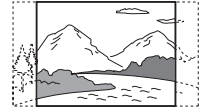

[16:9]



Note

- Depending on the DVD, [4:3 LETTER BOX] may be selected automatically instead of [4:3 PAN SCAN] or vice versa.

■ HDMI RESOLUTION

Selects the type of video signals output from the HDMI OUT (high-definition multimedia interface out) jack. When you select AUTO (default), the system outputs video signals of the highest resolution acceptable for your TV.

If the picture is not clear, natural or to your satisfaction, try another option that suits the disc and your TV/projector, etc. For details, refer also to the instruction manual supplied with the TV/projector, etc.

[AUTO]

Normally, select this.

[1920 × 1080i]

Sends 1920 × 1080i video signals.

[1280 × 720p]

Sends 1280 × 720p video signals.

[720 × 480p]

Sends 720 × 480p video signals.

[720 × 480i]

Sends 720 × 480i video signals.

Note

- Even when a setting other than “AUTO” is selected and the connected TV cannot accept the resolution, the system automatically adjusts the video signals that are suitable for the TV.

■ [SCREEN SAVER]

The screen saver image appears when you leave the system in pause or stop mode for 15 minutes, or when you play back a Super Audio CD, CD, or DATA CD (MP3 audio) for more than 15 minutes. The screen saver will help prevent your

display device from becoming damaged (ghosting). Press \triangleright to turn off the screen saver.

[ON] Turns on the screen saver.

[OFF] Turns off the screen saver.

■ [BACKGROUND]

Selects the background color or picture on the TV screen in stop mode or while playing a Super Audio CD, CD, or DATA CD (MP3 audio).

[JACKET PICTURE] The jacket picture (still picture) appears, but only when the jacket picture is already recorded on the disc (CD-EXTRA, etc.). If the disc does not contain a jacket picture, the [GRAPHICS] picture appears.

[GRAPHICS] A preset picture stored in the system appears.

[BLUE] The background color is blue.

[BLACK] The background color is black.

■ [BLACK LEVEL]

Selects the black level (setup level) for the video signals output from the jacks other than COMPONENT VIDEO OUT/HDMI OUT.

[ON] Sets the black level of the output signal to the standard level.

[OFF] Lowers the standard black level. Use this when the picture becomes too white.

■ [BLACK LEVEL (COMPONENT OUT)]

Selects the black level (setup level) for the video signals output from the COMPONENT VIDEO OUT jacks.

You cannot select this and the setting is not effective when the system outputs progressive signal.

[OFF] Sets the black level of the output signal to the standard level.

[ON] Raise the standard black level. Use this when the picture becomes too black.

■ [4:3 OUTPUT]

This setting is effective only when you set [TV TYPE] in [SCREEN SETUP] to [16:9] (page 79). Adjust to watch 4:3 aspect ratio progressive signals. If you can change the aspect ratio on your progressive format compatible TV, change the setting on your TV, not the system. Note that this setting is effective only for HDMI connection or progressive signals output from the COMPONENT VIDEO OUT jacks.

Note

- This setting is effective only when "P AUTO (PROGRESSIVE AUTO)" or "P VIDEO (PROGRESSIVE VIDEO)" is selected by using PROGRESSIVE (page 27).
- This setting is not effective when you use the HDMI OUT jack and set [HDMI RESOLUTION] to [720 × 480i] (page 79).

[FULL] Select this when you can change the aspect ratio on your TV.

[NORMAL] Select this when you cannot change the aspect ratio on your TV. Shows a 16:9 aspect ratio signal with black bands on left and right sides of the image.

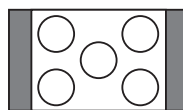

16:9 aspect ratio TV

Custom Settings

[CUSTOM SETUP]

Use this to set up playback related and other settings.

Select [CUSTOM SETUP] in the Setup Display. To use the display, see “Using the Setup Display” (page 77).

The default settings are underlined.

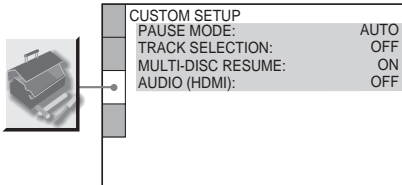

■ [PAUSE MODE] (DVD VIDEO/DVD-RW only)

Selects the picture in pause mode.

[AUTO]	The picture, including subjects that move dynamically, is output with no jitter. Normally select this position.
---------------	---

[FRAME]	The picture, including subjects that do not move dynamically, is output in high resolution.
----------------	---

■ [TRACK SELECTION] (DVD VIDEO only)

Gives the sound track which contains the highest number of channels priority when you play a DVD VIDEO on which multiple audio formats (PCM, DTS, MPEG audio, or Dolby Digital format) are recorded.

[OFF]	No priority given.
--------------	--------------------

[AUTO]	Priority given.
---------------	-----------------

Note

- When you set the item to [AUTO], the language may change. The [TRACK SELECTION] setting has higher priority than the [AUDIO] settings in [LANGUAGE SETUP] (page 78). (Depending on the disc, this function may not work.)
- If PCM, DTS, Dolby Digital sound, and MPEG audio tracks have the same number of channels, the system

selects PCM, DTS, Dolby Digital sound, and MPEG audio tracks in this order.

■ [MULTI-DISC RESUME] (DVD VIDEO/VIDEO CD only)

Switches the Multi-disc Resume setting on or off. Resume playback point can be stored in memory for up to 40 different DVD VIDEO/VIDEO CD discs (page 37).

[ON]	Stores the resume settings in memory for up to 40 discs.
-------------	--

[OFF]	Does not store the resume settings in memory. Playback restarts at the resume point only for the current disc in the system.
--------------	--

■ AUDIO (HDMI)

Selects the type of audio signal output from the HDMI OUT jack.

[OFF]	The sound is not output from the HDMI OUT jack.
--------------	---

[AUTO]	Outputs audio signals that is matched to the requested audio stream from the connected TV.
---------------	--

[PCM]	Converts Dolby Digital, DTS (digital theater system), or 96 kHz/24 bit PCM (pulse code modulation) signals to 48 kHz/ 16 bit PCM (pulse code modulation).
--------------	---

Note

- A loud noise (or no sound) will be output if you connect the system to a TV that is not compatible with DOLBY DIGITAL/DTS (digital theater system) signals and [AUTO] is selected. In this case, select [PCM].
- When you connect the system and TV with the HDMI cord and [AUTO] or [PCM] is selected, DUAL MONO, AUDIO DRC, A/V SYNC, DSGX, and sound field functions are not applied to the sound that is output from the TV.

Settings for the Speakers

[SPEAKER SETUP]

To obtain the best possible surround sound, set for the size of the speakers you have connected and their distance from your listening position. Then use the test tone to adjust the level and the balance of the speakers to the same level.

Select [SPEAKER SETUP] in the Setup Display. For details, see “Using the Setup Display” (page 77).

The default settings are underlined.

Note

- You cannot operate these setup items when you connect headphones to the system.

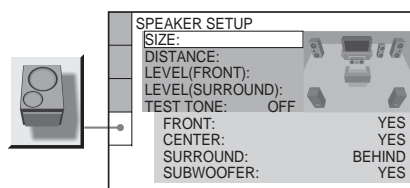

To return to the default setting when changing a setting

Select the item, then press CLEAR. Note that only the [SIZE] setting does not return to the default setting.

■ [SIZE]

If you do not connect center or surround speakers, or move the surround speakers, set the parameters for [CENTER] and [SURROUND] and specify the surround speaker position. Since the front speaker setting is fixed, you cannot change them.

Position diagram

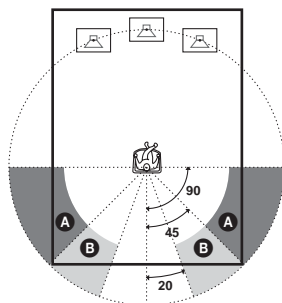

[FRONT]	[YES]
[CENTER]	[YES]: Normally select this. [NONE]: Select this if no center speaker is used.
[SURROUND]	[BEHIND]: Select this if surround speakers are located in section B . [SIDE]: Select this if surround speakers are located in section A . [NONE]: Select this if no surround speaker is used.
[SUBWOOFER]	[YES]

Note

- When you select an item, the sound cuts off for a moment.
- Depending on the settings of other speakers, subwoofer may be excessive.

■ [DISTANCE]

The default distance setting for the speakers in relation to the listening position is shown below. When you set the distance using the Quick Setup (page 33), the settings is automatically displayed.

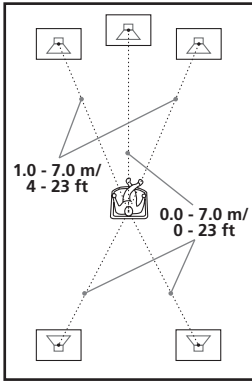

Be sure to change the value in the Setup Display when you move the speakers.

[FRONT]
3.0 m/10 ft* Front speaker distance from the listening position can be set in 0.2 meter (1 ft) increments from 1.0 to 7.0 meters (4 to 23 ft).

[CENTER]
3.0 m/10 ft* Center speaker distance from the listening position can be set in 0.2 meter (1 ft) increments from 0.0 to 7.0 meters (0 to 23 ft).
(appears when you set [CENTER] to [YES] in the [SIZE] setting.)

[SURROUND]
3.0 m/10 ft* Surround speaker distance from the listening position can be set in 0.2 meter (1 ft) increments from 0.0 to 7.0 meters (0 to 23 ft).
(appears except when you set [SURROUND] to [NONE] in the [SIZE] setting.)

* When you perform the Quick Setup (page 33), the default settings are changed.

Note

- When you set the distance, the sound cuts off for a moment.
- If all front and surround speakers are not placed at an equal distance from your listening position, set the distance according to the closest speaker.
- Do not place the surround speakers farther away from your listening position than the front speakers.
- Depending on the input stream, the [DISTANCE] setting may not be effective.

■ **[LEVEL (FRONT)]**

You can vary the level of front speakers as follows. Be sure to set [TEST TONE] to [ON] for easy adjustment.

[L] 0 dB	Set this between -6 dB and 0 dB in 1 dB increments.
[R] 0 dB	Set this between -6 dB and 0 dB in 1 dB increments.
[CENTER] 0 dB	Set this between -6 dB and +6 dB in 1 dB increments. (appears when you set [CENTER] to [YES] in the [SIZE] setting.)
[SUBWOOFER] 0 dB	Set this between -6 dB and +6 dB in 1 dB increments.

■ **[LEVEL (SURROUND)]**

You can vary the level of surround speakers as follows. Be sure to set [TEST TONE] to [ON] for easy adjustment.

(This settings appear except when you set [SURROUND] to [NONE] in the [SIZE] setting.)

[L] 0 dB	Set this between -6 dB and +6 dB in 1 dB increments.
[R] 0 dB	Set this between -6 dB and +6 dB in 1 dB increments.

To adjust the volume of all the speakers at one time

Press VOLUME +/- on the system, or press VOLUME +/- on the remote.

■ **[TEST TONE]**

The speakers will emit a test tone to adjust [LEVEL (FRONT)] and [LEVEL (SURROUND)].

[OFF]	The test tone is not emitted from the speakers.
[ON]	The test tone is emitted from each speaker in sequence while adjusting level. When you select one of the [SPEAKER SETUP] items, the test tone is emitted from each speaker in sequence.

Adjusting the speaker level by using the test tone

- 1 Press **DISPLAY** when the system is in stop mode.

continued

The Control Menu appears.

- 2** Press \uparrow/\downarrow to select  [SETUP], then press ENTER.

The options for [SETUP] appear.

- 3** Press \uparrow/\downarrow to select [CUSTOM], then press ENTER.

The Setup Display appears.

- 4** Press \uparrow/\downarrow repeatedly to select [SPEAKER SETUP], then press ENTER or \rightarrow .

- 5** Press \uparrow/\downarrow repeatedly to select [TEST TONE], then press ENTER or \rightarrow .

- 6** Press \uparrow/\downarrow repeatedly to select [ON], then press ENTER.

You will hear the test tone from each speaker in sequence.

- 7** From your listening position, adjust the value of [LEVEL (FRONT)] or [LEVEL (SURROUND)] using $\leftarrow/\uparrow/\downarrow/\rightarrow$.

The test tone is emitted from only the speaker which you are adjusting.

- 8** Press ENTER when you have finished making adjustments.

- 9** Press \uparrow/\downarrow repeatedly to select [TEST TONE], then press ENTER.

- 10** Press \uparrow/\downarrow repeatedly to select [OFF], then press ENTER.

Note

- When you adjust the speaker settings, the sound cuts off for a moment.
- The test tone signals are not output from the HDMI OUT jack.

Additional Information

Precautions

On placement

- Place the system in a location with adequate ventilation to prevent heat build-up in the system.
- At high volume, over long periods of time, the cabinet becomes hot to the touch. This is not a malfunction. However, touching the cabinet should be avoided. Do not place the unit in a confined space where ventilation is poor as this may cause overheating.
- Do not block the ventilation slots by putting anything on the system. The system is equipped with a high power amplifier. If the ventilation slots are blocked, the unit can overheat and malfunction.
- Do not place the system on a soft surface such as a rug and do not block the ventilation holes.
- Do not place the system in a location near heat sources, or in a place subject to direct sunlight, excessive dust, or mechanical shock.

On operation

- If the system is brought directly from a cold to a warm location, or is placed in a very damp room, moisture may condense on the lenses inside the system. Should this occur, the system may not operate properly. In this case, remove the disc and leave the system turned on for about half an hour until the moisture evaporates.
- When you move the system, take out any disc. If you don't, the disc may be damaged.

On adjusting volume

- Do not turn up the volume while listening to a section with very low level inputs or no audio signals. If you do, the speakers may be damaged when a peak level section is suddenly played.

On cleaning

- Clean the cabinet, panel, and controls with a soft cloth slightly moistened with a mild detergent solution. Do not use any type of abrasive pad, scouring powder or solvent such as alcohol or benzene.
If you have any questions or problems concerning your system, please consult your nearest Sony dealer.

On cleaning discs

- Do not use a commercially available CD/DVD cleaning disc. It may cause a malfunction.

On your TV's color

- If the speakers should cause the TV screen to have color irregularity, turn off the TV then turn it on after 15 to 30 minutes. If color irregularity should persist, place the speakers farther away from the set.

IMPORTANT NOTICE

Caution: This system is capable of holding a still video image or on-screen display image on your television screen indefinitely. If you leave the still video image or on-screen display image displayed on your TV for an extended period of time you risk permanent damage to your television screen. Projection televisions are especially susceptible to this.

On moving the system

When you carry the system, use the following procedure to protect the inner mechanism.

- 1 Press FUNCTION repeatedly to select "DVD."
- 2 Make sure that all discs are removed from the system.
- 3 Press ■ and I/⏻ simultaneously. "MECHA LOCK" appears in the front panel display after "STANDBY."
- 4 Remove the AC power cord (mains lead) from the wall outlet (mains).

Notes about the Discs

On handling discs

- To keep the disc clean, handle the disc by its edge. Do not touch the surface.
- Do not stick paper or tape on the disc.



- Do not expose the disc to direct sunlight or heat sources such as hot air ducts, or leave it in a car parked in direct sunlight as the temperature may rise considerably inside the car.
- After playing, store the disc in its case.

On cleaning

- Before playing, clean the disc with a cleaning cloth. Wipe the disc from the center out.



- Do not use solvents such as benzine, thinner, commercially available cleaners, or anti-static spray intended for vinyl LPs.

This system can only play back a standard circular disc. Using neither standard nor circular discs (e.g., card, heart, or star shape) may cause a malfunction.

Do not use a disc that has a commercially available accessory attached, such as a label or ring.

Troubleshooting

If you experience any of the following difficulties while using the system, use this troubleshooting guide to help remedy the problem before requesting repairs. Should any problem persist, consult your nearest Sony dealer.

Power

The power is not turned on.

- Check that the AC power cord (mains lead) is connected securely.

If “PROTECT” and “UNPLUG” appears alternately in the front panel display.

Immediately unplug the AC power cord (mains lead) and check the following items.

- Are the + and – speaker cords short-circuited?
- Are you using only the specified speakers?
- Is anything blocking the ventilation holes of the system?

After checking the above items and fixing any problems, connect the AC power cord (mains lead) again and turn on the system. If the cause of the problem cannot be found even after checking all the above items, consult your nearest Sony dealer.

Picture

There is no picture.

- The video connecting cords are not connected securely.
- The video connecting cords are damaged.
- The system is not connected to the correct TV input jack (page 25).
- The video input on the TV is not set so that you can view pictures from the system.
- You have set progressive format but your TV cannot accept the signal in progressive format. In this case, return the setting to interlace format (the default setting) (page 27).
- Even if your TV is compatible with progressive format (525p/625p) signals, the image may be affected when you set progressive format. In this case, return the setting to interlace format (the default setting) (page 27).
- Re-connect the connecting cord securely.
- The system is connected to an input device that is not HDCP (high-bandwidth digital content protection) compliant (“HDMI” on the front panel does not light up). See page 96.

- If the HDMI OUT jack is used for video output, changing the [HDMI RESOLUTION] setting in [SCREEN SETUP] may solve the problem (page 79).

Connect the TV and the system using a video jack other than the HDMI OUT, and switch the TV's input to the connected video input so that you can see the on-screen displays. Change the [HDMI RESOLUTION] setting in [SCREEN SETUP], and switch the TV's input back to HDMI. If the picture still does not appear, repeat the steps and try other options.

Picture noise appears.

- The disc is dirty or flawed.
- If the picture output from your system goes through your VCR to get to your TV, the copy-protection signal applied to some DVD programs could affect picture quality. If you still experience problems even when you connect your system directly to your TV, try connecting your system to your TV's S video input (page 25, 30).

Even though you set the aspect ratio in [TV TYPE] of [SCREEN SETUP], the picture does not fill the screen.

- The aspect ratio on the disc is fixed.

Sound

There is no sound.

- The speaker cord is not connected securely.
- Press MUTE on the remote if "MUTING ON" is displayed in the front panel display.
- The system is in pause mode or in Slow-motion Play mode. Press \square to return to normal play mode.
- Fast forward or fast reverse is performed. Press \square to return to normal play mode.
- Check the speaker settings (page 82).
- Super Audio CD audio signals are not output from the HDMI OUT jack.
- The equipment connected to the HDMI OUT jack does not conform to the audio signal format, in this case set [AUDIO (HDMI)] in [CUSTOM SETUP] to [PCM] (page 81).

No sound is output from the HDMI OUT jack.

- The HDMI OUT jack is connected to a DVI (digital visual interface) device (DVI (digital visual interface) jacks do not accept audio signals).
- The HDMI OUT jack does not output Super Audio CD sound.

The left and right sounds are unbalanced or reversed.

- Check that the speakers and components are connected correctly and securely.

There is no sound from the subwoofer.

- Check the speaker connections and settings (page 15, 82).
- Set the sound field to "AUTO FORMAT DIRECT AUTO" (page 60).

Severe hum or noise is heard.

- Check that the speakers and components are connected securely.
- Check that the connecting cords are away from a transformer or motor, and at least 3 meters (10 ft) away from your TV set or a fluorescent light.
- Move your TV away from the audio components.
- The plugs and jacks are dirty. Wipe them with a cloth slightly moistened with alcohol.
- Clean the disc.

The sound loses stereo effect when you play a VIDEO CD, a CD, or an MP3.

- Set [AUDIO] to [STEREO] by pressing AUDIO (page 58).
- Make sure the system is connected properly.

The surround effect is difficult to hear when you are playing a Dolby Digital, DTS, or MPEG audio sound track.

- Make sure the sound field function is on (page 60).
- Check the speaker connections and settings (page 15, 82).
- Depending on the DVD, the output signal may not be the entire 5.1 channel. It may be monaural or stereo even if the sound track is recorded in Dolby Digital or MPEG audio format.

The sound comes from the center speaker only.

- Depending on the disc, the sound may come from the center speaker only.

No sound is heard from the center speaker.

- Check the speaker connections and settings.
- Make sure the sound field function is on (page 60).
- Depending on the source, the effect of the center speaker may be less noticeable.

No sound or only a very low-level sound is heard from the surround speakers.

- Check the speaker connections and settings.
- Make sure the sound field function is on (page 60).
- Depending on the source, the effect of the surround speakers may be less noticeable.

Operation

Radio stations cannot be tuned in.

- Check that the antenna (aerial) is connected securely. Adjust the antenna (aerial) or connect an external antenna (aerial) if necessary.
 - The signal strength of the stations is too weak (when tuning in with automatic tuning). Use direct tuning.
 - No stations have been preset or the preset stations have been cleared (when tuning by scanning preset stations). Preset the stations (page 73).
 - Press DISPLAY so that the frequency appears in the front panel display.
-

The remote does not function.

- There are obstacles between the remote and the system.
 - The distance between the remote and the system is too far.
 - The remote is not pointed at the remote sensor on the system.
 - The batteries in the remote are weak.
-

The disc does not play.

- There is no disc inserted.
 - The disc is upside down.
Insert the disc with the playback side facing down.
 - The system cannot play CD-ROMs, etc. (page 7).
 - The region code on the DVD does not match the system.
 - Moisture has condensed inside the system and may cause damage to the lenses. Remove the disc and leave the system turned on for about half an hour.
-

The MP3 audio track cannot be played.

- The DATA CD is not recorded in the MP3 format that conforms to ISO 9660 Level 1/Level 2 or Joliet.
 - The MP3 audio track does not have the extension “.MP3.”
 - The data is not formatted in MP3 even though it has the extension “.MP3.”
 - The data is not MPEG1 Audio Layer 3 data.
 - The system cannot play audio tracks in MP3PRO format.
 - The [MODE (MP3, JPEG)] setting has been set to [IMAGE (JPEG)] (page 48).
 - If you cannot change the [MODE (MP3, JPEG)] setting, re-load the disc or turn the system off, then on.
-

The JPEG image file cannot be played.

- The DATA CD is not recorded in a JPEG format that conforms to ISO 9660 Level 1/Level 2, or Joliet.
 - It has an extension other than “.JPEG” or “.JPG.”
 - It is larger than 3,072 (width) × 2,048 (height) in normal mode, or more than 3,300,000 pixels in Progressive JPEG.
 - It does not fit the screen (those images are reduced).
 - The [MODE (MP3, JPEG)] setting has been set to [AUDIO (MP3)] (page 48).
 - If you cannot change the [MODE (MP3, JPEG)] setting, re-load the disc or turn the system off, then on.
-

The MP3 audio tracks and JPEG image file starts playing simultaneously.

- [AUTO] has been selected in [MODE (MP3, JPEG)] (page 48).
-

The titles of album/track/file name are not displayed correctly.

- The system can only display numbers and letters of the alphabets. Other characters are displayed as [*].
-

A disc does not start playing from the beginning.

- Program play, Shuffle Play, or Repeat Play has been selected.
Press CLEAR to cancel these functions before playing a disc.
 - Resume Play has been selected.
During stop, press ■ on the system or the remote and then start playback (page 37).
 - The title, DVD or PBC menu automatically appears on the TV screen.
-

The system starts playing the disc automatically.

- The DVD features an auto playback function.
-

Playback stops automatically.

- Some discs may contain an auto pause signal.
While playing such a disc, the system stops playback at the auto pause signal.
-

You cannot perform some functions such as Stop, Search, Slow-motion Play, or Repeat Play.

- Depending on the disc, you may not be able to perform some of the operations above. See the operating manual that came with the disc.

Messages do not appear on the screen in the language you want.

- In the Setup Display, select the desired language for the on-screen display in [OSD] under [LANGUAGE SETUP] (page 78).

The language for the sound track cannot be changed.

- Multilingual tracks are not recorded on the DVD being played.
- The DVD prohibits changing the language for the sound track.

The subtitle language cannot be changed.

- Multilingual subtitles are not recorded on the DVD being played.
- The DVD prohibits changing the subtitles.

The subtitle cannot be turned off.

- The DVD prohibits turning off subtitles.

The angles cannot be changed.

- Multi-angles are not recorded on the DVD being played (page 64).
- The DVD prohibits changing the angles.

A disc cannot be ejected and “LOCKED” appears in the front panel display.

- Contact your Sony dealer or local authorized Sony service facility.

[Data error] appears on the TV screen when playing a DATA CD.

- The MP3 audio track/JPEG image file you want to play is broken.
- The data is not MPEG1 Audio Layer 3 data.
- The JPEG image file format does not conform to DCF.
- The JPEG image file has the extension “.JPG” or “.JPEG,” but is not in JPEG format.

The system does not work normally.

- Disconnect the AC power cord (mains lead) from the wall outlet (mains), then reconnect after several minutes.

Self-diagnosis Function

(When letters/numbers appear in the display)

When the self-diagnosis function is activated to prevent the system from malfunctioning, a 5-character service number (e.g., C 13 50) with a combination of a letter and 4 digits appears on the screen and the front panel display. In this case, check the following table.

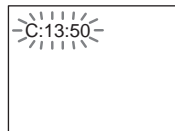

First 3 characters of the service number	Cause and/or corrective action
C 13	The disc is dirty. ➔ Clean the disc with a soft cloth (page 86).
C 31	The disc is not inserted correctly. ➔ Restart the system, then re-insert the disc correctly.
E XX (xx is a number)	To prevent a malfunction, the system has performed the self-diagnosis function. ➔ Contact your nearest Sony dealer or local authorized Sony service facility and give the 5-character service number. Example: E 61 10

Specifications

AUDIO POWER SPECIFICATIONS

POWER OUTPUT AND TOTAL HARMONIC DISTORTION:

With 3 ohm loads, both channels driven, from 200 – 20,000 Hz; rated 55 watts per channel minimum RMS power, with no more than 0.7 % total harmonic distortion from 250 milli watts to rated output.

Amplifier section

Surround mode (reference) music power output
Front: 143 W + 143 W
(with SS-TS46)
Center*: 143 W
(with SS-CT46)
Surround*: 143 W + 143 W
(with SS-TS43B)
Subwoofer*: 285 W
(with SS-WS42)

* Depending on the sound field settings and the source, there may be no sound output.

Inputs (Analog)

VIDEO 1, VIDEO 2 Sensitivity: 450 mV
Impedance: 50 kilohms

Inputs (Digital)

VIDEO 1 (Coaxial) Impedance: 75 ohms
VIDEO 2 (Optical)
Phones Accepts low-and high-impedance headphones.

Super Audio CD/DVD system

Laser Semiconductor laser
(Super Audio CD/DVD: λ = 650 nm)
(CD: λ = 790 nm)
Emission duration: continuous

Signal format system

Frequency response (at 2 CH STEREO mode)
DVD (PCM): 2 Hz to 22 kHz (± 1.0 dB)
CD: 2 Hz to 20 kHz (± 1.0 dB)

Tuner section

System PLL quartz-locked digital synthesizer system

FM tuner section
Tuning range 87.5 – 108.0 MHz
(100 kHz step)

Antenna (aerial) FM wire antenna (aerial)
Antenna (aerial) terminals 75 ohms, unbalanced
Intermediate frequency 10.7 MHz

AM tuner section
Tuning range 530 – 1,710 kHz (with the interval set at 10 kHz)
531 – 1,710 kHz (with the interval set at 9 kHz)

Antenna (aerial) AM loop antenna (aerial)
Intermediate frequency 450 kHz

Video section

Outputs Video: 1 Vp-p 75 ohms
S video:
Y: 1 Vp-p 75 ohms
C: 0.286 Vp-p 75 ohms
COMPONENT:
Y: 1 Vp-p 75 ohms
P_B/C_B, P_R/C_R: 0.7 Vp-p 75 ohms
HDMI OUT: Type A (19 pin)
Input VIDEO1, VIDEO2: 1 Vp-p 75 ohms

Speakers

Front

Speaker system Two-way Bass reflex, magnetically shielded

Speaker unit 70 × 100 mm (2 7/8 × 4 inches) cone type, 25 mm (1 inch) dia. balanced dome type

Rated impedance 2.7 ohms

Dimensions (approx.) 265 × 1,108 × 265 mm (10 1/2 × 43 5/8 × 10 1/2 inches) (w/h/d)

Mass (approx.) 3.5 kg (7 lb 12 oz)

Center

Speaker system Two-way Bass reflex, magnetically shielded

Speaker unit 55 × 110 mm (2 1/4 × 4 3/8 inches) cone type, 25 mm (1 inch) dia. balanced dome type

Rated impedance 2.7 ohms

Dimensions (approx.)	300 × 79 × 116 mm (11 7/8 × 3 1/8 × 4 5/8 inches) (w/h/d)
Mass (approx.)	1.2 kg (2 lb 10 oz)

Surround

Speaker system	Bass reflex
Speaker unit	70 × 100 mm (2 7/8 × 4 inches) cone type
Rated impedance	2.7 ohms
Dimensions (approx.)	86 × 165 × 102 mm (3 1/2 × 6 1/2 × 4 1/8 inches) (w/h/d)
Mass (approx.)	0.8 kg (1 lb 13 oz)

Subwoofer

Speaker system	Bass reflex, magnetically shielded
Speaker unit	200 mm (7 7/8 inches) cone type
Rated impedance	1.3 ohms
Dimensions (approx.)	206 × 382 × 392 mm (8 1/8 × 15 1/8 × 15 1/2 inches) (w/h/d)
Mass (approx.)	7.8 kg (17 lb 4 oz)

General

Power requirements	120 V AC, 60 Hz
Power consumption	On: 160 W Standby: 0.3 W (at the Power Saving Mode)
Dimensions (approx.)	445 × 70 × 375 mm (17 3/8 × 2 7/8 × 14 7/8 inches) (w/h/d) incl. projecting parts
Mass (approx.)	5.1 kg (11 lb 4 oz)
Supplied accessories	See page 13.
Design and specifications	are subject to change without notice.

Glossary

Album

Section of a music piece or an image on a data CD containing MP3 audio tracks or JPEG files.

Chapter

Subdivision of a title on a DVD. A title is composed of several chapters.

Dolby Digital

This movie theater sound format for is more advanced than Dolby Surround Pro Logic. In this format, the surround speakers output stereo sound with an expanded frequency range, and a subwoofer channel for deep bass is independently provided. This format is also called “5.1” with the subwoofer channel designed as the 0.1 channel (since it functions only when a deep bass effect is needed). All six channels in this format are recorded separately for superior channel separation. Furthermore, since all the signals are processed digitally, less signal degradation occurs.

Dolby Pro Logic II

Dolby Pro Logic II creates five full-bandwidth output channels from 2 channel sources. This is done using an advanced, high-purity matrix surround decoder that extracts the spatial properties of the original recording without adding any new sounds or tonal colorations.

■ Movie mode

The Movie mode is for use with stereo television shows and all programs encoded in Dolby Surround. The result is enhanced soundfield directionality that approaches the quality of discrete 5.1-channel sound.

■ Music mode

The Music mode is for use with any stereo music recordings, and provides a wide and deep sound space.

Dolby Surround Pro Logic

As one method of decoding Dolby Surround, Dolby Surround Pro Logic produces four channels from 2 channel sound. Compared with the former Dolby Surround system, Dolby Surround Pro Logic reproduces left-to-right panning more naturally and localizes sounds

continued

more precisely. To take full advantage of Dolby Surround Pro Logic, you should have one pair of surround speakers and a center speaker. The surround speakers output monaural sound.

DTS

Digital audio compression technology developed by Digital Theater Systems, Inc. This technology conforms to 5.1-channel surround. This format comprises of stereo rear channel and there is discrete subwoofer channel in this format. DTS provides the same 5.1 discrete channels of high quality digital audio. The good channel separation is realized due to the all channel data being recorded discretely and processed in digitally.

DVD

A disc that contains up to 8 hours of moving pictures even though its diameter is the same as a CD.

The data capacity of a single-layer and single-sided DVD, at 4.7 GB (Giga Byte), is 7 times that of a CD. Furthermore, the data capacity of a dual-layer and single-sided DVD is 8.5 GB, a single-layer and double-sided DVD 9.4 GB, and a dual-layer and double-sided DVD 17 GB. The picture data uses the MPEG 2 format, one of a worldwide standard of digital compression technology. The picture data is compressed to about 1/40 of its original size. The DVD also uses the variable rate coding technology that processes allocated data according to the status of the picture.

The audio data is recorded in Dolby Digital as well as in PCM, allowing you to enjoy more realistic audio presence.

Furthermore, various advanced functions such as the multi-angle, multilingual, and Parental Control functions are provided with the DVD.

DVD-RW

A DVD-RW is a recordable and rewritable disc that is the same size as a DVD VIDEO. The DVD-RW has two different modes: VR mode and Video mode. DVD-RWs created in Video mode have the same format as a DVD VIDEO, while discs created in VR (Video Recording) mode allow the contents to be programmed or edited.

DVD+RW

A DVD+RW (plus RW) is a recordable and rewritable disc. DVD+RWs use a recording format that is comparable to the DVD VIDEO format.

File

A JPEG image recorded on a DATA CD. ("File" is an exclusive definition for this system.) A single file consists of a single image.

Film based software, Video based software

DVDs can be classified as Film based or Video based software. Film based DVDs contain the same images (24 frames per second) that are shown at movie theaters. Video based DVDs, such as television dramas or sit-coms, displays images at 30 frames (or 60 fields) per second.

HDMI (high-definition multimedia interface)

HDMI is an interface that supports both video and audio on a single digital connection. The HDMI connection carries standard to high definition video signals and multi-channel audio signals to AV components such as HDMI equipped TVs, in digital form without degradation. Since the video signals are compatible with the current DVI (digital visual interface) format, HDMI jacks can be connected to DVI (digital visual interface) jacks by way of an HDMI -DVI (digital visual interface) converter cord. The HDMI specification supports HDCP (high-bandwidth digital contents protection), a copy protection technology that incorporates coding technology for digital video signals.

Interlace format
(Interlaced scanning)

The Interlace format is the NTSC standard method for displaying TV images at 30 frames per second. Each frame is scanned twice - alternately between the even numbered scanning lines and then odd numbered scanning lines, at 60 times per second.

Multi-angle function

Various angles of a scene, or viewpoints of the video camera are recorded on some DVDs.

Multilingual function

Several languages for the sound or subtitles in a picture are recorded on some DVDs.

Parental Control

A function of the DVD to limit playback of the disc by the age of the users according to the limitation level in each country. The limitation varies from disc to disc; when it is activated, playback is completely prohibited, violent scenes are skipped or replaced with other scenes and so on.

Playback Control (PBC)

Signals encoded on VIDEO CDs (Version 2.0) to control playback.

By using menu screens recorded on VIDEO CDs with PBC functions, you can enjoy playing simple interactive programs, programs with search functions, and so on.

Progressive format (sequential scanning)

In contrast to the Interlace format, the progressive format can reproduce 60 frames per second by reproducing all scanning lines (525 lines for the NTSC system). The overall picture quality increases and still images, text and horizontal lines appear sharper. This format is compatible with the 525 progressive format.

Region Code

This system is used to protect copyrights. A region number is allocated on each DVD system or DVD disc according to the sales region. Each region code is shown on the system as well as on the disc packaging. The system can play discs that match its region code. The system can also play discs with the “” mark. Even when the region code is not shown on the DVD, the region limit may still apply.

Scene

On a VIDEO CD with PBC (playback control) functions, the menu screens, moving pictures and still pictures are divided into sections called “scenes.”

Title

The longest section of a picture or music feature on a DVD, movie, etc., in video software, or the entire album in audio software.

Track

Section of a picture or a music piece on a VIDEO CD, CD, or MP3. An album is composed of several tracks (MP3 only).

VIDEO CD

A compact disc that contains moving pictures. The picture data uses the MPEG 1 format, one of a worldwide standard of digital compression technology. The picture data is compressed to about 1/140 of its original size. Consequently, a 12 cm VIDEO CD can contain up to 74 minutes of moving pictures.

VIDEO CDs also contain compact audio data. Sounds outside the range of human hearing are compressed while sounds we can hear are not compressed. VIDEO CDs can hold 6 times the audio information of conventional audio CDs. There are 2 versions of VIDEO CDs.

- Version 1.1: You can play only moving pictures and sounds.
- Version 2.0: You can play high-resolution still pictures and enjoy PBC functions.

This system conforms to both versions.

Language Code List

The language spellings conform to the ISO 639: 1988 (E/F) standard.





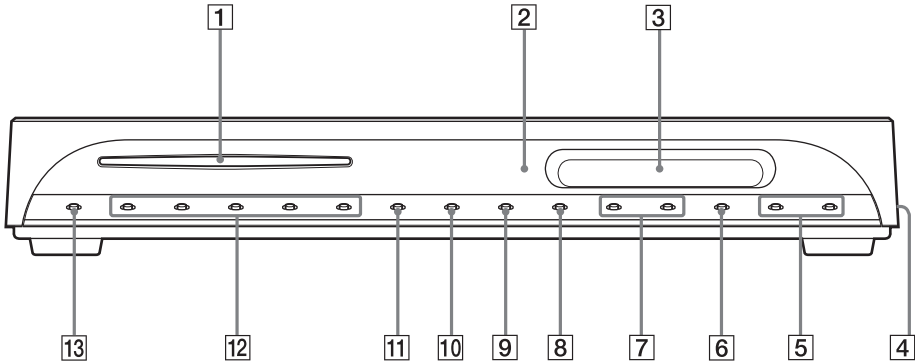

Code	Language	Code	Language	Code	Language
1027	Afar	1245	Inupiak	1489	Russian
1028	Abkhazian	1248	Indonesian	1491	Kinyarwanda
1032	Afrikaans	1253	Icelandic	1495	Sanskrit
1039	Amharic	1254	Italian	1498	Sindhi
1044	Arabic	1257	Hebrew	1501	Sangho
1045	Assamese	1261	Japanese	1502	Serbo-Croatian
1051	Aymara	1269	Yiddish	1503	Singhalese
1052	Azerbaijani	1283	Javanese	1505	Slovak
1053	Bashkir	1287	Georgian	1506	Slovenian
1057	Byelorussian	1297	Kazakh	1507	Samoa
1059	Bulgarian	1298	Greenlandic	1508	Shona
1060	Bihari	1299	Cambodian	1509	Somali
1061	Bislama	1300	Kannada	1511	Albanian
1066	Bengali; Bangla	1301	Korean	1512	Serbian
1067	Tibetan	1305	Kashmiri	1513	Siswati
1070	Breton	1307	Kurdish	1514	Sesotho
1079	Catalan	1311	Kirghiz	1515	Sundanese
1093	Corsican	1313	Latin	1516	Swedish
1097	Czech	1326	Lingala	1517	Swahili
1103	Welsh	1327	Laothian	1521	Tamil
1105	Danish	1332	Lithuanian	1525	Telugu
1109	German	1334	Latvian; Lettish	1527	Tajik
1130	Bhutani	1345	Malagasy	1528	Thai
1142	Greek	1347	Maori	1529	Tigrinya
1144	English	1349	Macedonian	1531	Turkmen
1145	Esperanto	1350	Malayalam	1532	Tagalog
1149	Spanish	1352	Mongolian	1534	Setswana
1150	Estonian	1353	Moldavian	1535	Tonga
1151	Basque	1356	Marathi	1538	Turkish
1157	Persian	1357	Malay	1539	Tsonga
1165	Finnish	1358	Maltese	1540	Tatar
1166	Fiji	1363	Burmese	1543	Twi
1171	Faroese	1365	Nauru	1557	Ukrainian
1174	French	1369	Nepali	1564	Urdu
1181	Frisian	1376	Dutch	1572	Uzbek
1183	Irish	1379	Norwegian	1581	Vietnamese
1186	Scots Gaelic	1393	Occitan	1587	Volapük
1194	Galician	1403	(Afan) Oromo	1613	Wolof
1196	Guarani	1408	Oriya	1632	Xhosa
1203	Gujarati	1417	Punjabi	1665	Yoruba
1209	Hausa	1428	Polish	1684	Chinese
1217	Hindi	1435	Pashto; Pushto	1697	Zulu
1226	Croatian	1436	Portuguese		
1229	Hungarian	1463	Quechua	1703	Not specified
1233	Armenian	1481	Rhaeto-Romance		
1235	Interlingua	1482	Kirundi		
1239	Interlingue	1483	Romanian		

Index to Parts and Controls

For more information, refer to the pages indicated in parentheses.

Front panel



- | | |
|---|---|
| 1 Disc slot (36) | 8 ■ (stop) (37, 76) |
| 2  (remote sensor) (13) | 9  (pause) (37) |
| 3 Front panel display (96) | 10  (play) (36) |
| 4 PHONES jack (36) | 11  (eject) (36, 76) |
| 5 VOLUME +/- (36) | 12 DISC 1-5 (36) |
| 6 FUNCTION (36) | 13  (on/standby) (32, 36, 76) |
| 7  (37) | |

Front panel display

About the indications in the front panel display

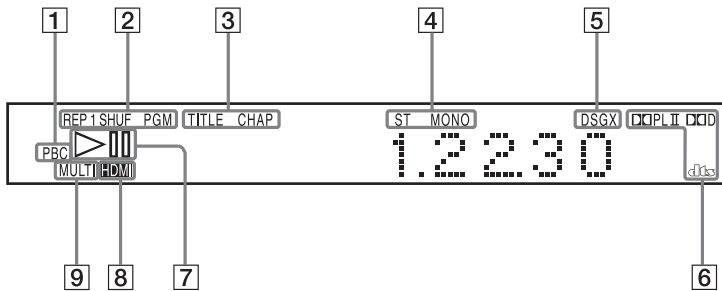

- 1 Lights up during PBC playback. (VIDEO CD only) (43)
- 2 Current mode (DVD function only)
- 3 Lights up when the time information of a title or chapter appears in the front panel display. (DVD only)
- 4 Monaural/Stereo effect (Radio only) (74)
- 5 Current sound effect (Except for Super Audio CD) (63)
- 6 Current surround format (Except for JPEG and Super Audio CD) (59)
- 7 Playing status (DVD function only)
- 8 Lights up when the HDMI OUT jack is correctly connected to a HDCP (high-bandwidth digital content protection) compliant device with HDMI or DVI (digital visual interface) input. (25)
- 9 Lights up during MULTI channel playback. (Super Audio CD only) (42)

Rear panel

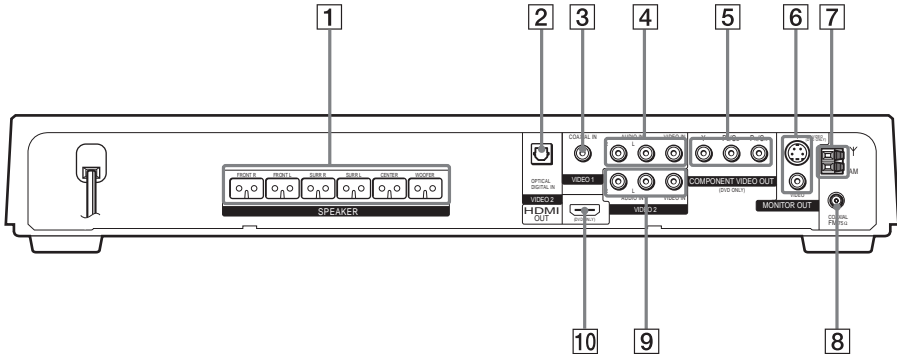

- 1 **SPEAKER jacks (15)**
- 2 **VIDEO 2 OPTICAL DIGITAL IN jack (30)**
- 3 **VIDEO 1 COAXIAL IN jack (30)**
- 4 **VIDEO 1 VIDEO/AUDIO IN jacks (28, 30)**
- 5 **COMPONENT VIDEO OUT jacks (25)**
- 6 **MONITOR OUT (VIDEO / S VIDEO) jacks (25)**
- 7 **AM terminal (24)**
- 8 **FM 75Ω COAXIAL jack (24)**
- 9 **VIDEO 2 VIDEO/AUDIO IN jacks (28, 30)**
- 10 **HDMI OUT jack (25)**

Remote

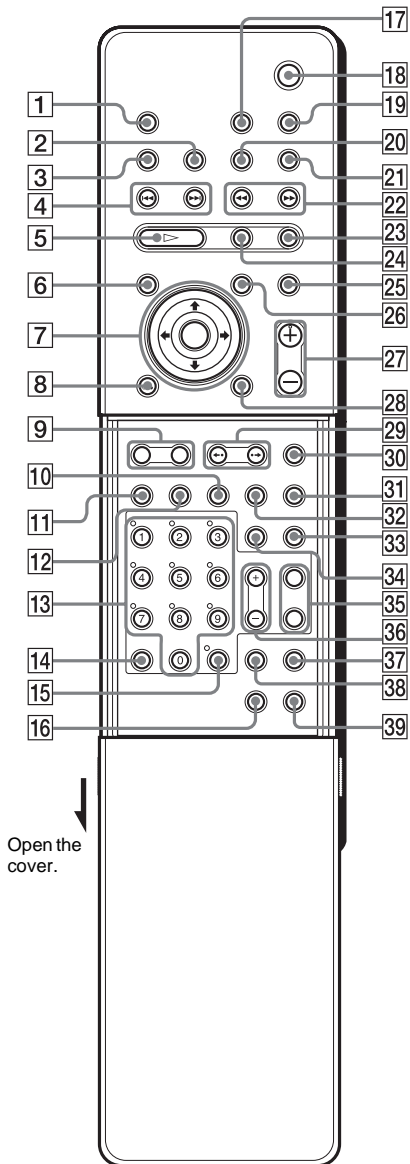

- 1 TV (69)
- 2 DISC SKIP (36)
- 3 SOUND FIELD (60)

- 4 **◀◀/▶▶** PRESET $-/+$, TV CH $-/+$ (33, 37, 74)
- 5 **▷** (play) (36)
The **▷** button has a tactile dot.*
- 6 **TOP MENU** (41)
- 7 **←/↑/↓/→/ENTER** (32, 38, 50, 60, 63, 65, 72, 77)
←/↑/↓/→ have tactile dots.*
- 8 **↶** RETURN (43)
- 9 **ALBUM $-/+$** (37, 70)
- 10 **ANGLE** (64)
- 11 **AUDIO** (58)
The AUDIO button has a tactile dot.*
- 12 **SUBTITLE** (64)
- 13 **Number buttons** (41, 65, 69)
The number 5 button has a tactile dot.*
- 14 **CLEAR, $-/-$** (33, 38, 70)
- 15 **ENTER**
- 16 **PROGRESSIVE, TUNER MENU** (27, 73)
- 17 **TV I/⏻** (on/standby) (69)
- 18 **I/⏻** (on/standby) (32, 36, 74)
- 19 **THEATRE SYNC** (70)
- 20 **TV/VIDEO, SLEEP** (69, 75)
- 21 **FUNCTION** (27, 36, 62, 72)
- 22 **◀◀/▶▶◀/▶▶▶** SLOW, TUNING $-/+$ (51, 73)
- 23 **■** (stop) (37, 65, 74)
- 24 **||** (pause) (37)
- 25 **MUTING** (37)
- 26 **MENU** (41)
- 27 **VOLUME, TV VOL $+/-$** (36, 74)
The VOLUME, TV VOL + button has a tactile dot.*
- 28 **☰** DISPLAY (10, 33, 38, 65, 77)
- 29 **◀◀◀/◀||/▶▶▶/▶▶▶** REPLAY, ADVANCE, STEP (37)
- 30 **DISPLAY** (74)
- 31 **DSGX** (63)
- 32 **PICTURE NAVI** (47)
- 33 **REPEAT** (40)
- 34 **FM MODE** (74)
- 35 **TV CH $-/+$** (69)
The TV CH + button has a tactile dot.*

36 TV VOL +/- (69)

37 MULTI/2CH (42)

38 SA-CD/CD (42)

39 AMP MENU (32, 50, 63, 72)

* Use the tactile dot as a reference when operating the system.

DVD Setup Display List

You can set the following items with the DVD Setup Display.

The order of the displayed items may be different from the actual display.

LANGUAGE SETUP

- OSD — (Select the language you want to use from the displayed language list.)
- MENU — (Select the language you want to use from the displayed language list.)
- AUDIO — (Select the language you want to use from the displayed language list.)
- SUBTITLE — (Select the language you want to use from the displayed language list.)

CUSTOM SETUP

- PAUSE MODE
 - AUTO
 - FRAME
- TRACK SELECTION
 - OFF
 - AUTO
- MULTI-DISC RESUME
 - ON
 - OFF
- AUDIO (HDMI)
 - OFF
 - AUTO
 - PCM

SCREEN SETUP

- TV TYPE
 - 16:9
 - 4:3 LETTER BOX
 - 4:3 PAN SCAN
- HDMI RESOLUTION
 - AUTO
 - 1920 × 1080i
 - 1280 × 720p
 - 720 × 480p
 - 720 × 480i
- SCREEN SAVER
 - ON
 - OFF
- BACKGROUND
 - JACKET
 - PICTURE GRAPHICS
 - BLUE
 - BLACK
- BLACK LEVEL
 - ON
 - OFF
- BLACK LEVEL (COMPONENT OUT)
 - OFF
 - ON
- 4:3 OUTPUT
 - FULL
 - NORMAL

SPEAKER SETUP

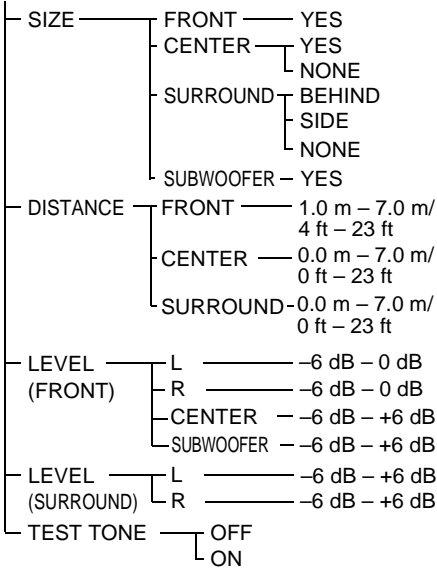

Additional Information

AMP Menu List

You can set the following items with AMP MENU on the remote.

AMP menu

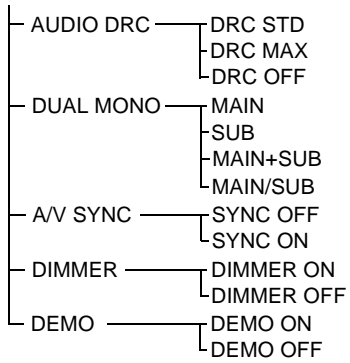

Index

Numerics

- 16:9 79
- 4:3 LETTER BOX 79
- 4:3 OUTPUT 80
- 4:3 PAN SCAN 79
- 5.1 Channel Surround 59

A

- A/V SYNC 50
- Accessories 13
- ALBUM 52
- Album 91
- AMP menu 32, 50, 63, 72
- AMP menu list 102
- ANGLE 64
- Antenna (aerial) Hookup 24
- AUDIO 78
- AUDIO DRC 63

B

- BACKGROUND 80
- Batteries 13
- BLACK LEVEL 80
- BLACK LEVEL
(COMPONENT OUT) 80

C

- CHAPTER 52
- Chapter 91
- COMPONENT VIDEO OUT
27
- Connecting the AC power cord
(mains lead) 32
- Continuous play 36
- Control Menu 10
- Controlling the TV 69
- CUSTOM 77
- CUSTOM PARENTAL
CONTROL 65
- CUSTOM SETUP 81

D

- DATA CD 46
- DEMO 32
- Demonstration 32
- Digital connection 31
- DIMMER 76
- DISC SKIP 37
- DISPLAY 55
- Display
Setup Display 77

- DISTANCE 82
- DOLBY DIGITAL 58
- Dolby Digital 91
- Dolby Pro Logic II 91
- Dolby Surround Pro Logic 91
- DSGX 63
- DTS 58, 92
- DUAL MONO 72
- DVD 92
- DVD+RW 92
- DVD's menu 41
- DVD-RW 42, 92

E

- EFFECT 50

F

- Fast forward 51
- Fast reverse 51
- FILE 52
- File 92
- Film based software 92
- Front Panel 95
- Front panel display 55, 96

H

- Handling discs 86
- HDMI (high-definition
multimedia interface) 25, 92
- AUDIO (HDMI) 81
- HDMI RESOLUTION 79
- Hooking up 25
- Hookup Overview 14

I

- INDEX 52
- Installing the speakers on the
wall 21
- Instant Advance 37
- Instant Replay 37
- Interlace format 92
- INTERVAL 49

J

- JPEG 44, 46

L

- Language Code List 94
- LANGUAGE SETUP 78
- LEVEL (FRONT) 83
- LEVEL (SURROUND) 83

- Listening to other components
72
- Listening to TV sound 62
- Locating
a specific point by watching
the TV screen 51

M

- MENU 78
- MODE (MP3, JPEG) 48
- MP3 44, 46
- Multi Session CD 7
- Multi-angle function 64, 92
- MULTI-DISC RESUME 81
- Multilingual function 93
- Multiplex broadcast sound 72
- Muting 37

N

- Naming preset stations 74

O

- On-screen display
Control Menu display 10
- Setup Display 77
- ORIGINAL 42
- OSD 78
- Other Component Hookup 30

P

- PARENTAL CONTROL 66, 93
- PAUSE MODE 81
- PBC Playback 7, 43, 93
- PICTURE NAVI 47, 54
- PLAY LIST 42
- Preset Station 73
- Program Play 38
- PROGRESSIVE AUTO 27
- Progressive format 27, 93
- PROGRESSIVE VIDEO 27

Q

- Quick Setup 33

R

- Radio 74
- Rear Panel 97
- Region Code 8, 93
- Remote 13, 69, 98
- Repeat Play 40
- RESET 78

continued

Resume Play 37

S

S VIDEO 26

Scan 51

SCENE 52

Scene 93

SCREEN SAVER 79

SCREEN SETUP 79

Searching 51

SETUP 77

Setup Display 77, 100

Shuffle Play 39

SIZE 82

SLEEP 75

Slide show 48

Slow-motion play 51

Sound Field 60

SPEAKER SETUP 82

Speaker setup 35

Speaker System Hookup 15

SUBTITLE 64, 78

Super Audio CD 7, 42

T

TEST TONE 83

THEATRE SYNC 70

TIME/TEXT 53

TITLE 52

Title 93

TRACK 52

Track 93

TRACK SELECTION 81

Troubleshooting 86

TUNER MENU 73

TV Hookup 25

TV TYPE 79

U

Usable discs 6

V

VIDEO CD 93